

COUNTY OF SUFFOLK



STEVEN BELLONE  
SUFFOLK COUNTY EXECUTIVE

SUFFOLK COUNTY  
DEPARTMENT OF HEALTH SERVICES  
DIVISION OF ENVIRONMENTAL QUALITY

**STANDARDS FOR APPROVAL OF PLANS  
AND CONSTRUCTION FOR  
SEWAGE DISPOSAL SYSTEMS FOR  
OTHER THAN SINGLE-FAMILY RESIDENCES**

July 21, 2020

Gregson H. Pigott, MD, MPH  
Commissioner of Health Services

Walter Dawydiak, PE, JD  
Director of Environmental Quality



**TABLE OF CONTENTS**

<b><u>Section</u></b>	<b><u>Page</u></b>
I. INTRODUCTION .....	4
II. DEFINITIONS APPLICABLE TO THESE STANDARDS .....	4
III. PROHIBITION OF INSTALLATION OF SEWAGE DISPOSAL SYSTEMS .....	10
IV. PLANS/PERMIT TO CONSTRUCT/APPROVALS REQUIRED .....	11
V. INSPECTION/CERTIFICATION OF CONSTRUCTED WORKS REQUIRED .....	12
VI. FINAL APPROVAL OF CONSTRUCTED WORKS REQUIRED .....	13
VII. DETERMINING POPULATION DENSITY EQUIVALENT .....	14
VIII. DETERMINING DENSITY LOAD .....	15
IX. DETERMINING DESIGN SEWAGE FLOW .....	15
X. DETERMINING TYPE AND REQUIREMENTS FOR SEWAGE DISPOSAL SYSTEM .....	20
XI. LOCATION/SITING OF SEWAGE DISPOSAL SYSTEM .....	22
XII. SUBSOIL AND GROUNDWATER CONDITIONS .....	26
XIII. CONSTRUCTION MATERIALS REQUIREMENTS .....	29
XIV. SEPTIC TANK REQUIREMENTS .....	29
XV. GREASE TRAP REQUIREMENTS .....	36
XVI. INNOVATIVE AND ALTERNATIVE ONSITE WASTEWATER TREATMENT .....	42
XVII. LEACHING STRUCTURE REQUIREMENTS .....	51
XVIII. MANHOLE REQUIREMENTS .....	57
XIX. GRAVITY SEWER LINE REQUIREMENTS .....	60
XX. SEPARATION OF SEWER AND WATER LINES .....	63
XXI. SEPARATION OF SEWER AND DRAINAGE LINES .....	64
XXII. BACKFILL AND FINAL GRADING .....	64

XXIII. SEWAGE PUMP STATIONS .....65

XXIV. SEWAGE FORCE MAINS .....69

XXV. PUMP-OUT FACILITIES .....71

XXVI. ALTERNATIVE SEWAGE DISPOSAL SYSTEMS .....72

XXVII. ABANDONMENT OF EXISTING SEWAGE DISPOSAL SYSTEMS .....73

XXVIII. COVENANTS AND RESTRICTIONS .....74

XXIX. VARIANCES .....74

XXX. APPROVAL BY THE COMMISSIONER OF HEALTH SERVICES .....74

**LIST OF TABLES**

<b><u>Table</u></b>	<b><u>Page</u></b>
TABLE 1 – PROJECT DENSITY LOADING RATES & DESIGN SEWAGE FLOW RATES .....	16
TABLE 2 – MINIMUM HORIZONTAL SEPARATION DISTANCES .....	25
TABLE 3 - APPLICATION RATES .....	29

**LIST OF FIGURES**

<b><u>Figure</u></b>	<b><u>Page</u></b>
FIGURE 1 – TYPICAL SOIL PERCOLATION TEST ARRANGEMENT .....	75
FIGURE 2 – SINGLE UNIT CONCRETE SEPTIC TANK.....	76
FIGURE 3 – TWO UNIT CONCRETE SEPTIC TANK.....	77
FIGURE 4 – MULTIPLE UNIT CONCRETE SEPTIC TANK (3 & 4 Units) .....	78
FIGURE 5 – MULTIPLE UNIT CONCRETE SEPTIC TANK (5 & 6 Units) .....	79
FIGURE 6 – SINGLE UNIT CONCRETE GREASE TRAP .....	80
FIGURE 7– MULTIPLE UNIT CONCRETE GREASE TRAP.....	81
FIGURE 8 – CONCRETE LEACHING POOL DESIGN AND CONSTRUCTION DETAILS .....	82
FIGURE 9 – CONCRETE LEACHING POOL ARRANGEMENT/LAYOUT .....	83

FIGURE 10 – TYPICAL CONCRETE LEACHING GALLEY AND LAYOUT.....84

FIGURE 11 – CONCRETE ACCESS/JUNCTION MANHOLE .....85

FIGURE 12 – CONCRETE DROP MANHOLE .....86

FIGURE 13 – CONCRETE DISTRIBUTION MANHOLE .....87

FIGURE 14 – CONCRETE SAMPLING MANHOLE.....88

FIGURE 15 – TYPICAL CLEAN-OUT DETAIL .....89

FIGURE 16 – PRE-CAST CLUSTERED DISPOSAL SYSTEM FOR HIGH GROUNDWATER .....90

**LIST OF APPENDICES**

APPENDIX A – STANDARDS FOR APPROVAL AND CONSTRUCTION OF MODIFIED SEWAGE DISPOSAL SYSTEMS AND SMALL COMMUNITY SEWERAGE SYSTEMS

APPENDIX B – STANDARDS FOR APPROVAL AND CONSTRUCTION OF SEWAGE COLLECTION SYSTEMS AND TREATMENT WORKS

APPENDIX C – REQUIREMENTS OF DEPARTMENT OF HEALTH SERVICES AND RESPONSIBILITIES OF LICENSED DESIGN PROFESSIONALS IN INSPECTING ON-LOT SEWAGE TREATMENT SYSTEMS OR COLLECTION SYSTEMS

**STANDARDS FOR  
APPROVAL OF PLANS AND CONSTRUCTION FOR  
SEWAGE DISPOSAL SYSTEMS FOR  
OTHER THAN SINGLE FAMILY RESIDENCES**

## **I. INTRODUCTION**

These are the Suffolk County Department of Health Services Standards for the Administration of Section 502, of Article 5 (Sewage Disposal), Sections 607-613 of Article 6, Sections 705, 706, 709-716 of Article 7, and Article 19 of the Suffolk County Sanitary Code.

The purpose of these standards is to provide a means for achieving protection of the groundwater from excessive contaminant loading and to assure a safe, sanitary means of disposing of wastewater. Diseases such as infectious hepatitis, typhoid fever and dysentery can be transmitted by water, food, insects, pets, and toys contaminated by human waste. Properly designed, maintained and operated sewage disposal systems minimize the possibility of disease transmission and the potential for contamination of ground and surface waters.

These standards apply to commercial, industrial, multiple residential or other buildings and only address sewage as herein defined. Other solid, liquid or gaseous emissions or discharges are subject to a separate review and approval by the Department. For details relating to single-family residences, refer to “**Standards for Approval of Plans and Construction for Sewage Disposal Systems for Single-Family Residences**”.

## **II. DEFINITIONS APPLICABLE TO THESE STANDARDS**

**AASHTO H-20 Loading.** AASHTO is the American Association of State Highway and Transportation Officials. H-20 refers to the manufacture of sewage disposal system components and access covers capable of withstanding a 16,000 lb./sq. ft. live load, caused by traffic conditions. H-20 loading simulates the load due to a 20-ton truck.

**Acre.** Forty-Three Thousand Five Hundred Sixty (43,560) square feet.

**Absorption Area.** An area to which wastewater is distributed for infiltration to the soil.

**Adjusted Gross Land Area.** Gross land area of a parcel minus area of regulated freshwater or tidal wetlands and ponds or other underwater lands.

**Alternative Sewage Disposal System.** A subsurface sewage disposal system which contains design elements not explicitly described herein or components that are arranged differently than shown in the conventional layouts of these standards.

**Apartment.** A premises occupied by an individual or family which is leased or rented from a corporation, entity, or another individual. Apartments are considered multiple residential units.

**ASTM.** American Society for Testing and Materials.

**AWWA.** American Water Works Association.

**Backfill.** a) The operation of refilling an excavation, usually after some structure or pipe has been placed therein; b) the material placed in an excavation in the process of backfilling.

**Cesspool.** Any buried chamber, including, but not limited to any perforated metal tank, perforated concrete or block vault or hollow excavation, which receives direct discharges of wastewater from a building sewer for the purpose of collecting solids and discharging liquid to the surrounding soil.

**Clean Sand.** Soil classified in accordance with ASTM D-2487 (Unified Soil Classification System) as SW or SP.

**Clean-out.** A device brought to grade to facilitate cleaning of sewer lines.

**Collection System.** The network of sewer pipes, structures and devices installed for the purpose of collecting and transporting sewage to the sewage disposal, sewage treatment or sewer system.

**Commercial Projects.** Restaurants, office buildings, nursing homes, hospitals, assisted living facilities, warehouses, hotels, motels or any other type of project not considered a single-family residence.

**Community Sewage Treatment System.** A system utilized for the collection and disposal of sewage or other waste of a liquid nature, including the various devices for the treatment of such wastes, serving more than one parcel, whether owned by a municipal corporation, private utility, or otherwise. A community sewage treatment system requires acceptance by the Suffolk County Sewer Agency.

**Conventional Septic System or Conventional Onsite Wastewater Treatment System (OWTS).** An onsite sanitary system consisting of a septic tank and any associated interconnecting piping, a leaching structure(s) and any associated interconnecting piping that does not have any active or mechanical means of treatment or any supplemental filtration components.

**Density Load.** The quantity of sewage expected to be discharged from existing and/or proposed permanent structure(s) on a parcel, excluding kitchen/gray load, expressed in gallons per day per applicable unit and utilized to evaluate the need for sewage treatment when compared to the population density equivalent for the project.

**Density Loading Rate.** The flow factor established by Department standards to determine the density load of a parcel based on the use of the parcel.

**Department.** The Suffolk County Department of Health Services.

**Design Professional.** A person licensed or registered in the State of New York and authorized by the State Education Law to design the systems described in these standards.

**Design Sewage Flow.** The sum of the hydraulic load(s) from all uses of a building(s) on a parcel and utilized to determine the size of the sewage disposal system.

**Distribution Manhole.** A type of manhole used to distribute equal volumes of sewage to multiple leaching structures, or sewage system components.

**Drop Manhole.** A type of manhole used when the difference in elevation between the inflow and outflow sewer line exceeds two feet.

**Grease Trap.** A watertight chamber, which promotes the separation of fats and greases from sewage.

**Gross Floor Area.** The floor area of all levels, within the exterior walls of a building or enclosed structure. Unfinished and/or mechanical spaces within cellars and attics are not included in the gross floor area.

**Groundwater.** The subsurface water occupying the zone of saturation below the established water table.

**Groundwater Management Zone.** Any of the areas delineated in Suffolk County by the "Long Island Comprehensive Waste Treatment Management Plan (L.I. 208 Study)," as revised by the "Long Island Groundwater Management Plan," and subsequent revisions adopted by the Suffolk County Board of Health identifying differences in regional hydrogeology and groundwater quality conditions. The boundaries of the Groundwater Management Zones are set forth on a map adopted by the Board, filed in the Office of the Commissioner.

**Groundwater Monitoring Well.** A well introduced into a particular aquifer for the purpose of obtaining samples of the groundwater for chemical analysis.

**Highest Recorded Groundwater.** The highest recorded groundwater elevation based upon the historic data of both the Department of Health Services and the United States Geological Survey.

**Hydraulic Load.** The sum of the density load and kitchen/gray Load for a particular use of a building on a parcel expressed in terms of gallons per day per applicable unit.

**Individual Sewerage System.** Any onsite sanitary system consisting of a septic tank and/or I/A OWTS tank(s) with any associated interconnecting piping, a leaching structure(s) and any associated interconnecting piping. OWTS and I/A OWTS are classified as Individual Sewerage Systems.

**Innovative and Alternative Onsite Wastewater Treatment System(s) (I/A OWTS).** An onsite decentralized wastewater treatment system(s) that, at a minimum, is designed to reduce total nitrogen in treated effluent to 19 mg/l. An I/A OWTS can serve more than one parcel, but shall not be considered sewerage, Community Sewerage Systems, or Modified Subsurface Sewage Disposal (denitrification) by the Department under the Suffolk County Sanitary Code.

**Invert Elevation.** The lowest elevation of the inside of a sewer line, water line, or other piping.

**Kitchen/gray Load.** The volume of sewage discharged from food preparation and service areas, or other gray water uses from other construction projects (excluding residential uses such as, but not limited to, condominiums, two family residences, multi-family housing) expressed in terms of gallons per day per applicable unit, which has been omitted from the density load.

**Leaching Area.** The effective sidewall and/or bottom absorption area in a leaching structure, absorption trench, pool, galley. For leaching pools and galleys, it shall be sidewall area only.



**Leaching Pool or Galley.** A covered pit constructed with a perforated, reinforced concrete wall through which septic tank and/or I/A OWTS effluent infiltrate the surrounding soil.

**Liquid Depth.** The depth measured from the bottom of a septic tank or grease trap to the outlet invert elevation.

**Maintenance Provider.** A private entity hired by a property owner to provide operation and maintenance and contractual service for an I/A OWTS.

**Manhole.** A watertight chamber used for smooth redirection of sewage flow and/or to provide access to sewer lines.

**Modified Subsurface Sewage Disposal System.** An onsite sewage treatment system or treatment works which includes processes capable of meeting applicable discharge standards of total nitrogen in treated effluent of 10mg/l or less and where the designed sewage treatment capacity of the system shall not exceed 15,000 gallons per day.

**Multiple Residential Projects.** All residential construction other than detached single-family housing units each on its own separate lot. Examples include two-family houses, apartment complexes, town homes, condominiums, co-ops, mobile home parks, or other similar arrangements.

**Municipal Sewage Treatment System.** A system utilized for the collection and disposal of sewage, or other waste of a liquid nature, including the various devices for the treatment (treatment works) of such wastes, serving a municipal sewer district.

**NEC.** National Electrical Code published by the National Fire Protection Association.

**NEMA.** The National Electrical Manufacturers Association.

**NYSDEC.** The New York State Department of Environmental Conservation.

**Occupancy Rating.** The maximum number of persons permitted to occupy an establishment as determined by the appropriate agency.

**On - Site Sewage Treatment System.** A treatment system (treatment works) located on the same parcel as the building(s) it serves which includes processes capable of meeting applicable discharge standards.

**Operation and Maintenance (O&M).** The act of performing tasks specified by the Department and/or the manufacturer of an I/A OWTS, sewage treatment plants, and modified subsurface sewage disposal systems including, but not limited to, cleaning, inspection, and adjustment of control settings to ensure proper operation of the system and related components.

**Operation and Maintenance Contract.** A signed contract between the property owner and the maintenance provider setting forth all required Operation and Maintenance procedures and monitoring schedules along with effective dates of the contract.

**OWTS Replacement.** The abandonment and/or removal of an existing individual sewerage system or cesspool and installation of a new individual sewerage system.

**OWTS Retrofit.** The modification or alteration of an existing cesspool or individual sewerage system. Such modification or alteration shall include, but not be limited to: the replacement or addition of a septic tank, grease trap, components of an I/A OWTS, lift station, pump station, distribution box or manhole to an existing Sewage disposal system; replacement or addition of new leaching structures to an existing sewage disposal system; or replacement, addition, or re-configuration of sewage disposal system piping, control panel, pumps or other appurtenances.

**Perched Groundwater.** Groundwater, which is separated from the main body of groundwater by an aquiclude (e.g. a clay lens).

**Planned Retirement Community (PRC).** A multiple residential project in which each unit is required by law or regulation to be occupied by at least one resident per unit who is 55 years of age or older.

**Population Density Equivalent.** The maximum density load permitted to be discharged from a parcel utilizing an individual sewerage system in the absence of a community sewerage system, a sewage treatment system or a modified subsurface sewage disposal system, based on the calculated population per unit area expressed in gallons per day.

**Property Owner.** The holder of the legal and/or equitable title to real property.

**PVC pipe.** A type of flexible thermoplastic pipe, manufactured from ethylene and chlorine, which may be used for sewer lines.

**Registration.** The approval process by which a property owner completes and submits routine documentation required by the Department to certify his/her/its ownership and use of an I/A OWTS.

**Responsible Management Entity.** The Department, which shall administer and conduct a comprehensive set of activities and have the legal authority and technical capacity to ensure the long term operation, maintenance, and management of all I/A OWTS.

**Rooming House.** A building arranged or used for lodging for compensation, where group-sleeping accommodations are provided in one room, or a series of rooms, and shared bathroom and kitchen areas may be provided.

**SCDPW.** The Suffolk County Department of Public Works

**Standard Dimension Ratio (SDR).** The ratio of the outside pipe diameter to the pipe wall thickness.

**Septic Tank.** A watertight chamber used for the settling, stabilizing and anaerobic decomposition of sewage.

**SEQRA.** State Environmental Quality Review Act. A process that requires the consideration of environmental factors in the planning stages of a proposed action(s).

**Sewage.** Water-carried human or animal wastes from residences, institutions, businesses, commercial buildings and establishments, and industrial buildings and establishments or a combination thereof, together with kitchen/gray load. Industrial wastes or other wastes shall not be considered sewage for

purposes of this Standard unless otherwise stated. "industrial wastes" and "other wastes" have the meanings as defined in Environmental Conservation Law sections 17-0105(5) and (6).

**Sewage Disposal System.** Any plumbing or conveyances, which result in or are capable of resulting in a discharge of sewage. This includes, but is not limited to, building sewers, septic tanks, I/A OWTS leaching structures, sumps, tile fields, holding tanks, treatment works, outfalls, and connecting piping. The term may also refer to a part of a larger disposal system.

**Sewage Pump.** Any type of device designed for the purpose of pumping sewage or other liquid wastes. Some examples of sewage pumps include the following:

1. **Grinder Pump.** A type of submersible sewage pump used to cut, shred, or reduce in size, solids found in raw sewage.
2. **Positive Displacement Pump.** A type of pump capable of pumping raw sewage or liquids at a constant rate while utilizing various pressure heads.
3. **Submersible Sewage Pump.** A type of pump designed to operate while submerged in sewage.
4. **Vacuum Pump.** A type of pump capable of pumping air or a mixture of air and liquid.

**Sewage Pump Station.** A structure that contains pumps, piping, and other equipment used for the purpose of receiving, temporarily storing, and pumping sewage.

**Sewage Recharge Bed.** A designated area exposed to the atmosphere where treated wastewater is distributed for the purpose of infiltrating the surrounding soil.

**Sewage Treatment Plant (STP).** A sewage treatment system which includes processes capable of meeting applicable discharge standards of total nitrogen in treated effluent of 10mg/l or less and where the design sewage flow exceeds 15,000 gpd. I/A OWTS are not Sewage Treatment Plants.

**Sewage Treatment System.** A sewage disposal system consisting of a sewage collection system and treatment works.

**Sewer Line.** A pipe designed to convey sewage. Examples include the following:

1. **House Connection.** The gravity sewer line which extends from the face of the building to the sewage disposal or sewer system.
2. **Lateral or Branch Sewer Line.** The gravity sewer line used to collect sewage from one or more building sewers or house connections.
3. **Main Sewer Line.** The gravity sewer line used to collect sewage from one or more lateral or branch sewer lines.
4. **Sewage Force Main.** A sewer line designed to receive the sewage discharged from a pumping station and convey it under pressure to the point of discharge.

**Sewer System.** (Also referred to as sewage collection system, public sanitary sewer, municipal sewage disposal system, privately owned communal sewerage system, and communal sewage disposal system) Pipelines, conduits, pumping stations, and force mains, and all other constructions, devices, and appliances appurtenant thereto, used for conveying sewage to a point of ultimate disposal.

**SPDES (State Pollutant Discharge Elimination System) Permit.** A permit, issued by the NYSDEC, authorizing discharges of 1,000 gallons per day or greater to the ground or surface waters of New York State.

**Stormwater Recharge Basin.** A designated area exposed to the atmosphere where stormwater is collected and distributed for the purpose of infiltrating the surrounding soil.

**Subsurface Sewage Disposal System.** A sewage disposal system designed to treat and dispose of septic tank, I/A OWTS or other treatment facility effluent, in the absence of a community sewerage system, sewage treatment system or modified subsurface sewage disposal system, by application of the effluent to a soil surface at a depth below the surface of the ground.

**Suffolk County Sewer Agency (Sewer Agency).** The agency responsible for directing the means and method of sewage disposal for projects involving multiple ownership where the Suffolk County Health Department or other municipal entity has determined that sewage treatment is required.

**Thrust Block or Restraint.** A device used to resist thrust forces due to changes in alignment or direction of force mains.

**Treatment Works.** A facility designed for the purposes of removing certain components from sewage by mechanical, chemical or biological means, and stabilizing and disposing of sewage. The facility shall meet New York State Department of Environmental Conservation discharge requirements. I/A OWTS are not treatment works.

**USGS.** United States Geological Survey. (Also, the NYS Building Code refers to the USC&GS - United States Coast and Geodetic Survey.)

**Valve Chamber.** A separate concrete box or chamber used to contain and access valves for the purpose of flow control or to isolate pumping units without having to enter the pump station.

**Wet Well.** The portion of a sewage pump station that receives and temporarily stores sewage.

### III. PROHIBITION OF INSTALLATION/USE OF SEWAGE DISPOSAL SYSTEMS

1. The installation of a sewage disposal system(s) is prohibited by the Suffolk County Sanitary Code unless a permit to construct has been issued by the Commissioner.
2. The installation of an I/A OWTS is prohibited unless a permit to construct the I/A OWTS has been issued by the Department.
3. The construction of a new building or an addition to an existing building is prohibited unless the proposed sewage disposal system(s) serving such building has been approved by

the Department and/or the existing sewage disposal system(s) have been approved by the Department for the additional use.

4. The construction of a building or building addition without plumbing or additional sewage disposal facilities is prohibited unless sewage disposal system(s) serving such facilities have been certified to the Department by a licensed design professional as capable of accepting sewage flows generated by the use of such new facilities and such facilities conform to the density load requirements of the Department.
5. A change in use or renovation to an existing building that may affect the density load or design sewage flow is prohibited unless the proposed sewage disposal system(s) serving such building has been approved by the Department and/or the existing sewage disposal systems have been approved by the Department for the additional use.
6. The occupancy of a building(s) and/or the use of a sewage disposal system(s) is prohibited without (final) approval of constructed works by the Department.
7. The installation of individual subsurface sewerage system(s) or alternative sewage disposal system(s) is prohibited when the site to be developed is within the boundaries of a municipal sewer district or is served by an on-site/community sewage treatment system.

#### **IV. PLANS / PERMIT TO CONSTRUCT / APPROVALS REQUIRED**

1. Plans / Permits Required to Construct
  - a) Written Approval of Plans Required Prior to Construction

Written approval of plans is required before start of construction of new subsurface sewage disposal systems and components. Approval of Plans is also required prior to the start of construction of all new buildings, building additions with or without internal plumbing, or changes in use or renovations of existing buildings that may affect sewage flows or density load. Plans shall be prepared by a Design Professional and shall conform to these standards and guidelines issued by the Department. These plans once signed and approved by an authorized representative of the Department, in conjunction with form WWM-016, become a permit to construct a sewage disposal system. Refer to **Application Requirements For Sewage Disposal Facilities & Water Supply Systems For Other Than Single Family Residences - Form WWM-003**. The approved site plan must be at the site and available during construction of the sanitary system.

Written approval of plans is required before start of construction of all new I/A OWTS and components for proposed and existing buildings or modifications to existing I/A OWTS and components. Plans shall be prepared by a Design Professional and shall conform to these standards and guidelines issued by the Department. These plans once signed and approved by an authorized representative of the Department, in conjunction with form WWM-016, become a permit to construct a sewage disposal system. Refer to **Application Requirements For Sewage Disposal Facilities &**

### **Water Supply Systems For Other Than Single Family Residences - Form WWM-003.**

Written approval of plans is also required prior to construction of sewage collection facilities, Modified Subsurface Sewage Disposal Systems, On-site sewage treatment systems, or Community Sewage Systems. Refer to **Application Requirements For Sewage Disposal Facilities & Water Supply Systems For Other Than Single Family Residences – Form WWM-003**, as well as **Appendix A** and **Appendix B** of these standards. In addition, separate residential applications must be submitted to and approved by the Department for projects involving condominiums or other attached residences prior to construction.

#### b) Responsibility of Design Professional

The design professional retained to design the sewage disposal system, I/A OWTS, sewer system, or treatment works shall be responsible for all aspects of the system design. That responsibility includes gathering all design information as necessary, making the site evaluation, and creating the design. These standards shall not be construed as providing sufficiently detailed guidance as to relieve the design professional from undertaking whatever additional steps or measures that may be necessary to achieve an appropriate design.

#### 2. Permits / Approvals from other Agencies Required

##### a) Permits from other agencies

Permits from other agencies, where such permits may affect placement of the sewage disposal systems, shall be submitted to the Department prior to the Department's issuance of a permit to construct. Such permits include but are not limited to wetlands or natural resources permits from the New York State Department of Environmental Conservation, the Army Corps of Engineers, and/or the appropriate local regulatory authority (e.g. delegated agents for NYSECL Articles 15, 24, 25; Wild, Scenic & Recreational Rivers; Town natural resources permits, etc.).

b) A SPDES permit issued by the New York State Department of Environmental Conservation or its agent is required for all discharges to groundwater where the discharge to an outfall(s) is 1,000 gallons per day or greater.

c) Sewer district approval is required from Suffolk County Department of Public Works for county sewer districts or the appropriate agency for other sewer districts.

## **V. INSPECTION / CERTIFICATION OF CONSTRUCTED WORKS REQUIRED**

#### 1. Inspection by the Department Required

Sewage disposal systems, I/A OWTS, sewer systems, or treatment works constructed in Suffolk County shall conform to standards herein approved by the Commissioner of the Suffolk County Department of Health Services and plans approved by the Department.

Prior to backfilling, installed subsurface sewage disposal system components and piping shall be inspected and authorized for backfilling by a representative of the Department. The Department shall be notified in accordance with the permit conditions, provided with the approved plans, to schedule an inspection of the subsurface sewage disposal system components and piping. Backfilling prior to Department inspection is prohibited and may result in an order by the Commissioner to remove all backfill for inspection. The property lines shall be “staked” in order to ascertain that the system is located on the property in accordance with these standards. All mechanical and electrical components associated with the sanitary system must be inspected by the Department to verify that they are in working condition. Refer to **Instructions for Obtaining Final Health Approval of Constructed Projects for Other than Single-Family Residences – Form WWM-019** for additional inspection requirements for sewer systems and treatment works.

2. Excavation Inspection Required

In the case of unacceptable soil and/or groundwater conditions, inspection of the excavation by a representative of the Department is required prior to the installation of the leaching structures including leaching pools, leaching galleys, absorption trenches or other leaching structures/systems.

3. Separate Certification of Construction May Be Required

In certain instances, the Department may also require a separate certification of construction by a Design Professional for various aspects of the project as noted in the Permit Conditions issued at the time of approval.

## VI. FINAL APPROVAL OF CONSTRUCTED WORKS REQUIRED

1. Final Approval of Constructed Works Required

Final approval of constructed works is necessary to operate or discharge into constructed sewage disposal systems, I/A OWTS, sewer systems, or treatment works. In addition, occupancy of a building(s) is prohibited without the issuance of final approval by the Department.

2. As-Built Plans Required

Final approval of constructed works will be granted to the applicant on as-built plans, which are to be submitted after the final satisfactory field inspection is completed. Plans are to be signed and sealed by a licensed professional engineer or architect except a licensed surveyor may sign for conventional subsurface sewage disposal systems only. Refer to **Instructions for Obtaining Final Health Approval of Constructed Projects for Other than Single-Family Residences – Form WWM-019** for the as-built plan requirements.

### 3. Other Requirements

For further information, refer to **Instructions for Obtaining Final Health Department Approval of Constructed Projects for Other Than Single-Family Residences – Form WWM-019** and **Appendix C** of these standards.

## VII. DETERMINING POPULATION DENSITY EQUIVALENT

A population density equivalent estimate must be made in order to determine the type of sewage disposal system required for a project, and to determine if a project meets the density requirements of Article 6 of the Suffolk County Sanitary Code. There are two alternative acceptable methods for determining population density equivalent, a **Calculation Method**, or a **Yield Map Method**.

### 1. Calculation Method

#### a) Commercial Projects

Population density equivalent is calculated by multiplying the adjusted gross lot area in acres (43,560 sq.ft./acre) by 600 gallons per day/acre (300 gallons per day per acre in Groundwater Management Zones III, V, or VI, or where a community water supply is not being provided). Adjusted gross lot area is obtained by subtracting the area of regulated freshwater wetlands, tidal wetlands, ponds, or other underwater lands from the land area as delineated and shown on official surveys and site plans.

#### b) Multiple Residential Projects

The population Density Equivalent is calculated as seventy-five percent (75%) of adjusted gross land area in square feet (sq. ft.), multiplied by 600 gallons / day / 40,000 sq. ft. of land area (300 gallons / day / 40,000 sq. ft. of land area in Groundwater Management Zones III, V, or VI, or when a community water supply is not being provided). The resultant value is the population density equivalent expressed as gallons / day.

Adjusted gross lot area is obtained by subtracting the area of regulated freshwater wetlands, tidal wetlands, ponds, or other underwater lands from the land area as delineated and shown on official surveys and site plans.

### 2. Yield Map Method

The Yield Map Method may be used as an alternative method for calculating population density equivalent. A map illustrating the location of building lots together with roads, recharge basins, and other appurtenances as would normally be necessary to develop single-family lots on the site, shall be submitted for a lot yield determination by the Department. All lot areas and dimensions must be shown together with recharge basin calculations. Lot configurations should conform to local Town/Village zoning requirements for similar sized lots, and minimum zoning requirements should be specified on the maps. Yield maps shall be signed and sealed by the licensed design professional.



Regulated freshwater wetlands, tidal wetlands, ponds, or other underwater lands may be shown as part of the lots on a yield map. However, an applicant must demonstrate that all lots shown on the yield map will conform to the requirements of the Department with respect to the location of individual sanitary systems and water supply on these delineated lot areas or by the appropriate agencies having jurisdiction.

All lots shown on a yield map must be at least 20,000 sq.ft. in area (40,000 sq.ft. in Groundwater Management Zones III, V, or VI, or where a community water supply is not being provided).

The population density equivalent, in gallons / day, is obtained by multiplying the number of building lots by 300 gallons / lot / day.

### **VIII. DETERMINING DENSITY LOAD**

Density Load is the sum of all density loads generated on a site. Density Load is derived from occupancy ratings and/or from density loading rates shown in Table 1 below. For mixed type buildings such as office/warehouse an appropriate density-loading rate should be used to calculate the proportionate density load for each building use as applicable. The (total) Density Load is the sum of the proportionate density loads for all existing and proposed uses on the site. The density load does not include the kitchen/gray load from the site.

### **IX. DETERMINING DESIGN SEWAGE FLOW**

The Design Sewage Flow for a project is derived from the hydraulic load rates shown in Table 1 below. For a mixed type building(s) such as office/warehouse, the design sewage flow rate should be calculated as the sum of all hydraulic loads for each individual use within the building(s). The Design Sewage Flow may be apportioned appropriately if more than one sewage disposal system is being proposed or modified.

**TABLE 1 - PROJECT DENSITY LOADING RATES & DESIGN SEWAGE FLOW RATES**  
**(Based upon gross floor area in square feet (sf) unless otherwise noted)**

Structure Use	Density Load	Kitchen/Gray Load	Hydraulic Load
<b>FOOD SERVICE</b>			
Bar (in restaurant)	10 gpd/seat	5 gpd/seat	15 gpd/seat
Bar, Tavern, Disco (no fixed seating)	10 gpd/occupant <sup>1</sup>	5 gpd/occupant <sup>1</sup>	15 gpd/occupant <sup>1</sup>
Bar (outdoor/seasonal)	5 gpd/seat	2.5 gpd/seat	7.5 gpd/seat
Cafeteria (open to public)	See Primary use + 5 gpd/seat	2.5 gpd/seat	Primary use + 7.5 gpd/seat
Cafeteria/Continental Breakfast (not open to public)	See Primary Use	2.5 gpd/seat	Primary use + 2.5 gpd/seat
Snack Bar	See Primary Use	0.12 gpd/sf	Primary use + 0.12 gpd/sf
Juice Bar	See Primary Use	2.5 gpd/seat	Primary use + 2.5 gpd/seat
Catering Hall	5 gpd/seat	2.5 gpd/seat	7.5 gpd/seat
Outside Patio Dining	5 gpd/seat	10 gpd/seat	15 gpd/seat
Restaurant (full service or single services > 16 seats <sup>2</sup> )	10 gpd/seat	20 gpd/seat	30 gpd/seat
Wet store w/ food (Deli/take-out with max 16 seats single service <sup>2</sup> )	0.03 gpd/sf	0.12 gpd/sf	0.15 gpd/sf
Convenience store/Market/Farm Stand	0.03 gpd/sf	0.02 gpd/sf	0.05 gpd/sf
Commercial Bakery	0.04 gpd/sf	0.02 gpd/sf	0.06 gpd/sf
Wine/Beer Tasting (in a winery/brewery only) <sup>10</sup>	5 gpd/occ	2.5 gpd/occ	7.5 gpd/occ
<b>GENERAL INDUSTRIAL</b>			
General Industrial <sup>3</sup>	0.04 gpd/sf	Industrial process water <sup>4</sup>	0.04 gpd/sf
Greenhouse	0.03 gpd/sf	N/A	0.03 gpd/sf
<b>MEDICAL</b>			
Drug Rehabilitation	75 gpd/bed	See note <sup>5</sup>	75 gpd/bed
Mental Health Residence	75 gpd/bed	See note <sup>5</sup>	75 gpd/bed
Hospital	300 gpd/bed	See note <sup>5</sup>	300 gpd/bed
Nursing Home	150 gpd/bed	See note <sup>5</sup>	150 gpd/bed
Assisted Living	110 gpd/bed	See note <sup>5</sup>	110 gpd/bed
Medical office space	0.10 gpd/sf	N/A	0.10 gpd/sf
Dialysis Center	0.10 gpd/sf	Dialysis process water <sup>4</sup>	0.10 gpd/sf
Veterinary <sup>6</sup>	0.10 gpd/sf + 10 gpd/animal boarding	N/A	0.10 gpd/sf + 10 gpd/animal boarding

Structure Use	Density Load	Kitchen/Gray Load	Hydraulic Load
<b>MUNICIPAL SERVICES</b>			
Library, firehouse, precinct, museum, art gallery (w/ meeting rooms)	0.03 gpd/sf + 5 gpd/occupant <sup>1</sup> for meeting rooms	2.5 gpd/occupant <sup>1</sup>	0.03 gpd/sf + 5 gpd/occupant <sup>1</sup> + 2.5 gpd/occupant <sup>1</sup>
Library, firehouse, precinct, museum, art gallery (w/o meeting rooms)	0.03 gpd/sf	2.5 gpd/occupant <sup>1</sup>	0.03 gpd/sf + 2.5 gpd/occupant <sup>1</sup>
<b>OFFICE</b>			
Non-medical office space	0.06 gpd/sf		0.06 gpd/sf
<b>RECREATION</b>			
Bath house/comfort station	5 gpd/occupant <sup>1</sup>	5 gpd/shower/occupant <sup>1</sup> + Food service <sup>7</sup>	5 gpd/occupant <sup>1</sup> + 5 gpd/shower/occupant + Food service <sup>7</sup>
Bowling alley/tennis court/racquetball	100 gpd/court or alley	Food service <sup>7</sup>	100 gpd/court or alley + Food service <sup>7</sup>
Miniature golf	15 gpd/parking space	Food service <sup>7</sup>	15 gpd/parking space + Food service <sup>7</sup>
Ice/roller Skating Rink	15 gpd/skater <sup>1</sup> + 5 gpd/spectator <sup>1</sup>	Food service <sup>7</sup>	15 gpd/skater <sup>1</sup> + 5 gpd/spectator <sup>1</sup> + Food service <sup>7</sup>
Recreation	15 gpd/parking space	Food service <sup>7</sup>	15 gpd/parking space + Food service <sup>7</sup>
Spa/Fitness Center/ Karate/Dance/etc. (w/ showers & amenities)	0.1 gpd/sf	0.2 gpd/sf + Food service <sup>7</sup>	0.3 gpd/sf + Food service <sup>7</sup>
Spa/Fitness Center/ Karate/Dance/etc. (w/o showers & amenities)	0.1 gpd/sf	Food service <sup>7</sup>	0.1 gpd/sf + Food service <sup>7</sup>
Marina	10 gpd/boat slip	Food service <sup>7</sup>	10 gpd/boat slip + Food service <sup>7</sup>
OTB	5 gpd/person	Food service <sup>7</sup>	5 gpd/person + Food service <sup>7</sup>
Theater	3 gpd/seat	Food service <sup>7</sup>	3 gpd/seat + Food service <sup>7</sup>
Horse Farm <sup>6</sup>	0.04 gpd/sf + 10 gpd/stall		0.04 gpd/sf + 10 gpd/stall
Camp Ground	10 gpd/camper	5 gpd/shower/camper	10 gpd/camper + 5 gpd/shower/camper
Billiard Hall	5 gpd/occ	2.5 gpd/occ	7.5 gpd/occ
<b>RESIDENTIAL</b>			
Single Family Residence	300 gpd		300 gpd
Two Family Residence	600 gpd		600 gpd

Structure Use	Density Load	Kitchen/Gray Load	Hydraulic Load
Rooming house	75 gpd/bed		75 gpd/bed
Motel/Hotel unit up to 400 sq.ft. gross floor area w/o kitchenette (w/kitchenette see Housing Unit)	100 gpd/unit		100 gpd/unit
Motel/Hotel unit > 400 sq.ft. gross floor area w/o kitchenette (w/kitchenette see Housing Unit)	150 gpd/unit		150 gpd/unit
Housing Unit <sup>8</sup> up to 450 sq.ft. gross floor area (1-bedroom maximum/unit)	110 gpd/unit		110 gpd/unit
Housing Unit <sup>8</sup> between 451-600 sq.ft. gross floor area	150 gpd/unit		150 gpd/unit
Housing Unit <sup>8</sup> between 601-1200 sq.ft. gross floor area	225 gpd/unit		225 gpd/unit
Housing Unit <sup>8</sup> > 1200 sq.ft. gross floor area	300 gpd/unit		300 gpd/unit
PRC unit up to 600 sq.ft. gross floor area	100 gpd/unit		100 gpd/unit
PRC unit between 601-1600 sq.ft. gross floor area	150 gpd/unit		150 gpd/unit
PRC unit between 1601-2000 sq.ft. gross floor area	225 gpd/unit		225 gpd/unit
PRC unit > 2001 sq.ft. gross floor area	300 gpd/unit		300 gpd/unit
<b>RETAIL</b>			
Dry store	0.03 gpd/sf		0.03 gpd/sf
Wet store w/o Food (Hair salon, nail salon, pet shop w/o animal boarding, etc.)	0.03 gpd/sf	0.07 gpd/sf	0.1 gpd/sf
Car Dealership	0.03 gpd/sf for showroom/offices + 0.04 gpd/sf for maintenance/storage areas		0.03 gpd/sf for showroom/offices + 0.04 gpd/sf for maintenance/storage areas
Massage/Tanning	0.03 gpd/sf		0.03 gpd/sf
Tattoo Parlor	0.03 gpd/sf		0.03 gpd/sf
<b>SCHOOL</b>			
Boarding school/Dormitory	75 gpd/capita <sup>1</sup>	2.5 gpd/capita <sup>1</sup>	77.5 gpd/capita <sup>1</sup>
Day School	5 gpd/capita <sup>1</sup>	2.5 gpd/capita <sup>1</sup>	7.5 gpd/capita <sup>1</sup>

Structure Use	Density Load	Kitchen/Gray Load	Hydraulic Load
<b>MISCELLANEOUS</b>			
Car Wash	0.04 gpd/sf	Car wash process water <sup>4</sup>	0.04 gpd/sf
Laundromat	0.03 gpd/sf	Laundromat process water <sup>4</sup>	0.03 gpd/sf
Funeral Home	0.05 gpd/sf	Funeral Home process water <sup>4</sup>	0.05 gpd/sf
House of Worship (w/ meeting rooms)	1.5 gpd/seat + 5 gpd/occupant <sup>1</sup> for meeting rooms	2.5 gpd/occupant <sup>1</sup>	1.5 gpd/seat + 5 gpd/occupant <sup>1</sup> + 2.5 gpd/occupant <sup>1</sup>
House of Worship (w/o meeting rooms)	1.5 gpd/seat	2.5 gpd/occupant <sup>1</sup>	1.5 gpd/seat + 2.5 gpd/occupant <sup>1</sup>
Public Storage <sup>9</sup>	0.04 gpd/sf		0.04 gpd/sf
Animal boarding <sup>6</sup>	0.03 gpd/sf + 10 gpd/animal		0.03 gpd/sf + 10 gpd/animal
Winery/Brewery <sup>10</sup>	0.04 gpd/sf	Winery/Brewery process water <sup>4</sup>	0.04 gpd/sf

- <sup>1</sup> Occupancy ratings can be determined using New York State Uniform Fire Prevention and Building Code as a guide.
- <sup>2</sup> Single Service means disposable plates, silverware & cups. Takeout seating is for waiting patrons and is not convertible to full seating or for density credit at full service restaurants.
- <sup>3</sup> General industrial buildings may contain up to 15% related office space without applying a proportionate office density loading or flow rating to the space. If office space exceeds 15% of gross floor area, then a proportionate office density loading or flow rating must be applied to the entire office space.
- <sup>4</sup> Process waters require a separate permit and disposal facilities – Consult Department.
- <sup>5</sup> A grease trap shall be provided for this installation, which is sized at 20 gpd/bed.
- <sup>6</sup> A separate sewage disposal system shall be provided for wastewater generated from animal boarding, horse stalls, or kennel areas.
- <sup>7</sup> Food (kitchen) flow is added according to the type of food service in the establishment.
- <sup>8</sup> Motel/Hotel with Kitchenettes, Cottages, Apartments, Condominiums, Mobile Homes, Trailers, or Co-Ops.
- <sup>9</sup> Public storage density and/or design flow may be reduced if restrictive covenants are recorded on the parcel.
- <sup>10</sup> Winery/Brewery with 15% or less of the floor area used for tasting shall use the Winery/Brewery Tasting rates. Winery/Brewery with greater than 15% of the floor area used for tasting shall use the Bar rates.

**Note: The above table is subject to amendment from time to time as data becomes available to the Department. The table will be republished as an addendum to these standards if and when revised.**

**X. DETERMINING TYPE AND REQUIREMENTS FOR SEWAGE DISPOSAL SYSTEM****1. Conventional Subsurface Sewage Disposal System or I/A OWTS**

If the Density Load for a project, as calculated in Section VIII, is less than or equivalent to the Population Density Equivalent, calculated in Section VII, then a Conventional Subsurface Sewage Disposal System or I/A OWTS may be acceptable to serve the project, provided all other applicable requirements of these standards can be met. Where the total design flow for a parcel is greater than 30,000 gpd, the disposal system must be separated into individual outfalls not to exceed 30,000 gpd per outfall.

A parcel that is separately assessed, as shown on the 1981 tax maps, shall be allowed a minimum Design Sewage Flow (density load + kitchen/gray load) of 300 gpd regardless of lot area utilizing a subsurface system provided all other applicable requirements of these standards can be met. This exemption is based upon total lot area of the project and shall not be additive if a project seeks to combine several undersized lots.

**2. Sewage Treatment Systems****a) Categories of Sewage Treatment Systems**

If the Density Load for a project exceeds the Population Density Equivalent, then the installation of a sewage treatment system will be required. Sewage treatment systems are broken down into the following categories:

**i. On-Site Sewage Treatment System**

If the project consists of a single lot, an On-Site Sewage Treatment System, as applicable, will be required to serve the project.

An On-Site Sewage Treatment System includes a sewage treatment facility located on the same parcel as the building(s) it serves, which includes processes capable of meeting applicable discharge standards. These systems must serve all the buildings and facilities located on the site. This type of system may be approved for projects constructed on a single parcel, which is not part of a realty subdivision or development that is proposed or has already been approved by the Department. A community water supply system must be provided to serve these projects.

**ii. Community Sewage Treatment System**

If the project consists of Condominiums, Town Homes, Homeowner's Association, or will serve two or more separate tax parcels; then a Community Sewage Treatment System, as applicable, will be required to serve the entire project.

Community sewage treatment systems include a sewage collection system, treatment works and sewage disposal facilities. The community sewage treatment

facility must be capable of producing an effluent meeting applicable discharge standards. In addition, projects served with these types of systems require acceptance by the Suffolk County Sewer Agency (SCSA), and must be reviewed and approved by the Suffolk County Department of Public Works. Design of these systems is covered in the GLUMRB - Recommended Standards for Wastewater Facilities - 2014 Edition, or the latest revision. Additional standards for construction of these facilities can be obtained from the Suffolk County Department of Public Works.

iii. Municipal Sewage Treatment System.

If the project is located within the boundaries of a county, town, or village sewer district, then the project must be served by the appropriate Municipal Sewage Treatment System.

b) Types of Treatment Works

On-Site, Community and Municipal Sewage Treatment Systems shall contain treatment works of a type and design acceptable to the Department as well as to the NYSDEC and SCSA, when applicable. These can be classified into two types depending upon the design sewage flow:

i. Modified Subsurface Sewage Disposal Systems

A modified subsurface sewage disposal system may be permitted when the Design Sewage Flow (density load + kitchen/gray load) generated from the project is less than or equal to 15,000 gallons/day. These systems must be capable of producing an effluent meeting applicable discharge standards. However, when the project Design Sewage Flow exceeds 1,000 gallon/day, the NYSDEC may also review the proposed system design and issue a SPDES permit for the facility prior to the Department issuing a permit to construct. Applicable guidelines and/or standards covering these systems can be found in **Appendix A**.

ii. Sewage Treatment Plant (STP) or Treatment Works

A Sewage Treatment Plant or Treatment Works may be permitted when the Design Sewage Flow (density load + kitchen/gray load) generated from the project is greater than 15,000 gallons/day. These systems must be capable of producing an effluent meeting applicable discharge standards. Applicable design standards can be found in the GLUMRB - Recommended Standards for Wastewater Facilities - 2014 Edition, or the latest revision, and **Appendix B**.

## XI. LOCATION / SITING OF SEWAGE DISPOSAL SYSTEMS

### 1. Priority Siting for Sewage Disposal Systems

Because the failure of sewage disposal systems has the potential for significant public health impact, first priority during planning shall be given to the location of sewage disposal systems over the location of other improvements on the property.

The design professional is responsible to consider the significance of the existing and proposed topography, soils, location of existing and proposed private and public water supply wells, surface waters, wetlands, and groundwater conditions. The design must take into consideration the planned locations of other improvements such as building locations, underground utilities, storm drainage structures, and construction on adjacent properties, property lines, and other limitations of a physical or legal nature.

### 2. Written approval of plans is required by the Department before the start of construction of all new I/A OWTS for proposed and existing buildings or modifications to existing I/A OWTS and components.

a) Applicants applying for an OWTS Retrofit or OWTS Replacement of an existing sewage disposal system with an approved I/A OWTS shall meet the requirements of these Standards to the greatest extent possible. The Department may permit reduced sewage disposal system setbacks per **Table 2** or reduced minimum system capacity without the need for a variance or waiver in accordance with the Suffolk County Sanitary Code on a case-by-case basis provided the site complies with the density requirements as stated in Article 6 of the Suffolk County Sanitary Code. If necessary, certain requirements under these Standards may be relaxed at the discretion of the Department provided the following:

- i. Applications submitted to the Department shall be for sole objective to perform an OWTS Replacement or OWTS Retrofit where the permanent structure is existing, there is no increase in hydraulic load from the structure based on existing Department approvals, no increase in the gross floor area or change in the footprint of the structure based on existing Department approvals, and the new system will be an improvement in wastewater treatment for the site.
- ii. An application for OWTS Replacement or OWTS Retrofit shall not propose any change of use, building renovation or any increased flow to the OWTS.
- iii. The protection of public health and the environment is given priority over all other considerations.
- iv. The proposed system does not reduce the setbacks to neighboring private wells as compared to the current system being replaced or retrofitted.
- v. The Design Professional certifies that the OWTS Replacement or OWTS Retrofit application meets the Standards to the greatest extent possible and that other alternatives are not feasible.
- vi. The Design Professional certifies that the OWTS Replacement or OWTS Retrofit application represents an improvement to existing conditions.
- vii. For some applications, the Department may require a covenant to be filed against the property indicating the sewage disposal system does not comply



with Department standards for OWTS Replacements or OWTS Retrofits.

3. Site Conditions Prohibited

Sewage Disposal Systems shall not be located:

- a) In any area subject to imminent erosion, which cannot be controlled so as to protect the sewage disposal system(s);
- b) In areas where the highest recorded groundwater level is less than one foot below the original ground surface;
- c) In areas with existing slopes greater than 15%, unless the site can be properly graded in accordance with these standards. Refer to Section XXII - Final Grading and Backfilling;
- d) In areas where the existing sub-soils contain meadow mat, bog, silts, clays, or other impervious material extending below the groundwater table;
- e) In areas where the groundwater conditions are not conducive to the proper functioning of subsurface sewage disposal systems;
- f) Where topography concentrates runoff onto or into the area where the system is proposed;
- g) In any area or under any part of a building, or other improvements that does or may prevent reasonable access for repair or maintenance of the system.
- h) In any area which may reasonably be expected to create a public health risk.

4. Site Condition Requirements

Sewage Disposal Systems shall be located:

- a) On land owned in fee by the applicant (except for Community or Municipal Sewage Treatment Systems);
- b) On the same parcel as the building(s) to be serviced (except for Community or Municipal Sewage Treatment Systems);
- c) In an area which is easily accessible for purposes of maintenance and/ or replacement of sewage disposal and treatment system components;
- d) In accordance with the minimum separation distances presented in Table 2 of these standards;
- e) In accordance with the minimum separation distances and other conditions listed in **Appendix A** and **Appendix B** as applicable.

## 5. Expansion Area Requirements

### a) Conventional or I/A OWTS Subsurface Sewage Disposal Systems

A land area shall be set aside and shown on the plans adequate to allow for a minimum of fifty percent (50%) expansion and/or replacement of the leaching system. The area provided for expansion shall be contiguous to the location of the planned system. Deepening the basic system is not permitted in lieu of this expansion area.

### b) On-site or Community Sewage Treatment Systems

An adequate area shall be set aside to allow for a minimum of one-hundred percent (100%) expansion and/or replacement of sewage treatment and disposal systems. The area provided for expansion shall be contiguous to the planned location of the treatment and disposal facilities. Deepening the leaching system is not permitted in lieu of this expansion area. Refer to **Appendix A or B**, of these standards, for additional information.

## 6. Other Site Specific Considerations

To protect the public water supply and the benefits that freshwater wetlands, tidal wetlands, streams, and other surface waters provide, all projects may be subject to a separate site review by the Department. The following criteria apply to these sites:

- a) Sewage disposal systems shall be located to maximize distances to public water supply wells. If the Department determines that insufficient distance exists to protect the well, further treatment may be required.
- b) Sewage disposal systems shall be located to maximize distances to regulate freshwater wetlands, tidal wetlands, ponds, streams, and other surface waters. See **Table 2** of these standards for specific separation distance requirements.
- c) Boundaries of wetlands, surface waters and flood zones shall be shown accurately on surveys and site plans. Wetlands are not regulated directly by the Department, only through standards and regulations of the NYSDEC, NYSDOH, and various other government agencies.

**TABLE 2 - MINIMUM HORIZONTAL SEPARATION DISTANCES**

<b>Table of Minimum Horizontal Separation Distances From:</b>	<b>Septic Tank, I/A OWTS, Pump Station, Grease Trap, or Manhole</b>	<b>Leaching Structure<sup>3</sup></b>	<b>Sewer Line, Force Main</b>
Building with Cellar	10 ft.	10 ft.	5 ft.
Building on Slab	5 ft.	10 ft.	5 ft.
Water Service Line/Laterals/Mains <sup>5</sup>	10 ft.	10 ft.	10 ft. <sup>4</sup>
Underground Utilities	5 ft.	5 ft.	5 ft.
Surface Water/Regulated Wetlands	75 ft.	100 ft.	50 ft.
Public Water Well <sup>2</sup>	200 ft.	200 ft.	50 ft.
Private Well <sup>1</sup>	100 ft.	150 ft.	50 ft.
Storm Drain/Stormwater Recharge Basin <sup>5</sup>	20 ft.	20 ft.	10 ft.
Catch Basins (non-leaching)/Drainage Pipe <sup>6</sup>	5 ft.	10 ft.	5 ft.
Leaching Structure <sup>8</sup>	8 ft.	8 ft.	10 ft. <sup>7</sup>
Septic Tank, Pump Station, Grease Trap, or Manhole <sup>9</sup>	5 ft.	8 ft.	5 ft.
Property Lines	5 ft.	10 ft.	5 ft.
Swimming Pool	20 ft.	20 ft.	5 ft.
Retaining Wall (water proof)	10 ft.	10 ft.	5 ft.
Fuel Storage Tanks (below ground)	20 ft.	20 ft.	10 ft.
Top of Embankment or Steep Slope (15 % slope or greater)	25 ft.	25 ft.	25 ft.
Bluffs	65 ft.	65 ft.	65 ft.

- <sup>1</sup> Increased distance between leaching pools and private wells may be required based upon the depth of the well(s) involved and the direction of groundwater flow. Refer to **Standards For The Design Of Individual Water Supply Systems**. Discharges from treatment works shall be located down gradient of the well or out of the groundwater flow path towards the well. **Precise groundwater flow direction measurements may be required.**
- <sup>2</sup> Significant discharges (generally greater than 5,000 gpd or those in proximity to wells) are subject to a separate site review by the Department.
- <sup>3</sup> Leaching pools for treatment works have different distance requirements. See **Appendix A** and **Appendix B** for distance requirements for leaching pools or recharge beds associated with modified subsurface sewage disposal systems and treatment works, respectively.
- <sup>4</sup> Water and sewer lines may be in the same trench if the water line is placed on an undisturbed bench or shelf so that the bottom of the water main is at least 18 inches higher than the top of the sewer and the sewer is not subject to settling, vibration, superimposed loads, or frost action.
- <sup>5</sup> A minimum of 10-foot separation is required between water service line/laterals/mains and the edge of all stormwater drainage leaching structures.
- <sup>6</sup> A minimum of 5-foot separation is required between water service line/laterals/mains and the edge of all stormwater drainage non-leaching structures and associated piping.
- <sup>7</sup> Sewer piping between clusters of leaching pools may be installed at lesser separation distances.
- <sup>8</sup> Distribution manholes or distribution boxes installed preceding gravelless absorption trench systems or other leaching structures (other than leaching pools or galleys) may be installed a minimum of 3ft to the leaching structures.
- <sup>9</sup> Multiple unit septic tanks and grease traps shall be considered one structure and therefore individual components may be installed at lesser separation distances.

## **XII. SUBSOIL AND GROUNDWATER CONDITIONS**

1. Subsoil conditions shall be shown on the plans. The nature of the soil shall be determined by excavation of one or more test holes at the site of the proposed subsurface sewage disposal system. The soil investigation shall be subject to the following conditions:

- a) Test Holes/Borings

The soils in the test holes/borings shall be classified using the ASTM Unified Soil Classification System (ASTM D-2487) as a reference. The test holes/borings shall be carried to a depth of three feet in excess of the proposed leaching pool bottom or seventeen feet, whichever is greater. In the case where unacceptable soil is encountered, the test hole/boring must be carried until a stratum of six feet of clean sand is reached (defined as SP or SW by ASTM standards). If groundwater is encountered less than seventeen feet from grade, then the test hole/boring must be extended a minimum of six feet into groundwater.

A test hole/boring log and grade elevation at the test hole shall be indicated on the plans. The log shall also indicate the date, time, and person responsible for the test hole. If groundwater is encountered, the groundwater elevation measured during the test hole/boring and the highest recorded groundwater elevation shall be shown.

- b) Responsibility of Design Professionals

The design professional, by providing this information on the submitted plan, is considered to be certifying the results. Test holes/borings listed as "by others" are unacceptable unless independently certified by a design professional. Test holes/borings undocumented as to time and location of test are not acceptable.

- c) Witnessed Test Excavations

Test excavations witnessed by a representative of the Department may be required prior to approval to construct in areas of unusually poor soils or high groundwater or where data on record with the Department indicates inconsistent conditions. Borings are not acceptable to be witnessed by the Department in lieu of open excavations.

- d) Interpretation of Soil Investigation

In the event that there is a question over the classification of any soil and its suitability for sewage disposal, a sieve analysis performed by a qualified laboratory or design professional may be required. The Department may also require a technical report, submitted by a design professional, where unsuitable soil conditions exist at a site.

- e) Removal of Soils Unsuitable for Leaching Systems/Structures

When installing leaching structures, unsuitable soils shall be removed and replaced with sand and gravel, acceptable to the Department, a three-foot collar extending down until a hydraulic connection is established with a minimum six-foot stratum of

acceptable material. In those areas where these criteria cannot be met, consult the Department.

## 2. SOIL PERCOLATION TESTS

- a) For leaching structures/systems, other than leaching pools or leaching galleys, that are not to be installed in sand and gravel (defined as SP or SW by ASTM standards) acceptable to the Department, soil percolations tests may be used to design the system.
- b) Unless otherwise stated, soil percolation tests must be performed in accordance with 10NYCR, Appendix 75-A and the NYSDOH “Residential Onsite Wastewater Treatment Systems Design Handbook.”
- c) Soil percolation test results must be certified by a Licensed Professional Engineer or Licensed Registered Architect and submitted to the Department for review.
- d) At least two percolation tests for up to 1,000 sq. ft. of absorption area should be performed in holes spaced uniformly throughout the site. If soil conditions are highly variable, more tests may be required. An additional percolation test is required for each additional 500 sq. ft. of absorption area.
- e) Percolation test shall be performed at the depth equivalent to the bottom of the proposed leaching structure.
- f) Acceptable application rates based on percolation rates are stated in Table 3.
- g) A maximum leaching rate of 1.20 gallons per day per square feet (0.95 gallons per day per square feet for an absorption bed) of leaching is permitted when using soil percolation test results to determine a leaching rate to calculate leaching area in lieu of installing leaching structures in sand and gravel (defined as SP or SW by ASTM standards).
- h) Leaching structures, other than leaching pools or leaching galleys, can be installed in soil classified as sand and gravel (defined as SP or SW by ASTM standards), based on certified test hole/boring information obtained and designed using a maximum leaching rate of 1.20 gallons per day per square foot without the need for a soil percolation test (0.95 gallons per day per square feet for leaching absorption beds) provided one of the following criteria is met:
  - i. The bottom of the leaching structure will be placed on virgin strata of 4ft of sand and gravel defined as SP or SWP by ASTM standards; or
  - ii. Soils are excavated to a 4ft strata of virgin sand and gravel defined as SP or SW by ASTM standards and then backfilled with clean sand and gravel defined as SP or SW.
- i) When percolation test exceeds 60 minutes per inch (30 minutes per inch for an absorption bed system) then 4ft of unsuitable soils shall be excavated below the

elevation of the proposed bottom of the leaching structure and properly disposed. The excavation shall be backfilled with sand and gravel defined as SP or SW by ASTM standards and the lowest application rate shall be utilized to design the system.

- j) In some case, the Department may require reduced application rates based on an evaluation of leaching structure technology.
- k) A percolation test is only an indicator of soil permeability and must be consistent with the soil classification of the site as determined from the test holes.
- l) Percolation Test Procedures (See Figure 1 for a typical soil percolation test layout):
  - i. Make sure proper construction safety practices are followed.
  - ii. Dig a hole with vertical sides approximately 12 inches wide on all four (4) sides or 12 inches in diameter. The depth of the test holes should be equivalent to the bottom elevation of the leaching structure. It is necessary to place washed aggregate in the lower two (2) inches of each percolation test hole or to employ another method that will reduce scouring and silting action when water is poured into the hole. The sides of percolation holes should be scraped to avoid smearing.
  - iii. Pre-soak the test hole by periodically filling the hole with water and allowing the water to seep away. This procedure should be performed for at least four (4) hours and should begin one (1) day before the test, except in clean, coarse sand and gravel. After the water from the final pre- soaking has seeped away, remove any loose soil that has fallen from the sides of the hole. Pre- soaking saturates the surrounding soil and allows for clay in the soil to swell, simulating when a system is in operation and receiving wastewater effluent.
  - iv. Pour clean water into the hole, with as little splashing as possible, to a depth of six (6) inches above the bottom of the test hole.
  - v. Observe and record the time in minutes required for the water to drop from the six (6) inch depth to the five (5) inch depth.
  - vi. Repeat the test a minimum of three (3) times until the time for the water to drop from six (6) inches to five (5) inches for two (2) successive tests is approximately equal (i.e.,  $\leq 1$  minutes for 1 – 30 min./inch;  $\leq 2$  minutes for 31-60 min./inch). The longest time interval to drop one (1) inch shall be taken as the stabilized rate of percolation and shall serve as the basis of design for the absorption system.
  - vii. A percolation test where results are inconsistent with the deep soil test pit evaluation should be disregarded, and the percolation test(s) performed again.

**TABLE 3 – APPLICATION RATES FOR ABSORPTION BEDS OR TRENCH LEACHING SYSTEMS BASED ON PERCOLATION TEST RESULTS**

<b>Percolation Rate (MPI)</b>	<b>Application Rate Trench System (gal/day/sq.ft.)</b>	<b>Application Rate Absorption Bed (gal/day/sq.ft.)</b>
0-5	1.20	0.95
6-7	1.00	0.80
8-10	0.90	0.70
11-15	0.80	0.60
16-20	0.70	0.55
21-30	0.60	0.45
31-45	0.50	Not Acceptable
46-60	0.45	Not Acceptable

### **XIII. CONSTRUCTION MATERIALS REQUIREMENTS**

All components used in the sewage disposal system shall comply with the appropriate National Sanitation Foundation, the American Society of Testing and Materials, the American Association of Highway and Traffic Office, and/or the American Water Works Association requirements. Concrete used in the construction of sewage disposal system components shall conform to ASTM - C33 and ASTM - C150 standards. Concrete reinforcement shall conform to ASTM - A185 and ASTM - A615 as applicable.

All materials shall be identified as to manufacturer and have identification visible at the time of inspection.

### **XIV. SEPTIC TANK REQUIREMENTS**

#### **1. General Requirements**

- a) All conventional subsurface and/or alternative sewage disposal systems shall contain a septic tank as part of the overall sanitary disposal system design. In cases where an I/A OWTS must have a septic tank installed prior to the I/A OWTS unit. The capacity of a septic tank for an I/A OWTS shall be determined in accordance with I/A OWTS manufacturer recommendations.
- b) Septic tanks shall be located below grade and outside the building in either paved or unpaved areas. Septic tanks shall be located in areas that are easily accessible for routine inspection and maintenance. Refer to Section XI for additional siting requirements.
- c) Septic tanks shall be designed to hold a volume of at least two days' Design Sewage Flow, and shall have a minimum capacity of 1200 gallons. The Design Sewage Flow for the project can be calculated from Section IX of these standards.
- d) Septic tanks shall be constructed of precast concrete, fiberglass or high-density polyethylene in accordance with this standard, 10NYCRR, Appendix 75-A, and the

NYS DEC “Design Standards For Intermediate Sized Wastewater Treatment Systems”. The use of steel septic tanks shall be prohibited.

- e) All septic tanks shall have (2) compartments meeting the following requirements:
  - i. The first compartment shall have a liquid volume of 50-75 percent of the required liquid volume.
  - ii. All single unit septic tanks shall be divided into two compartments divided by a traverse wall. The inlet compartment shall have 50-75 percent of the total capacity.
  - iii. The interior compartment wall (traverse wall) shall not extend to the interior roof without providing for venting equivalent to the area of a four (4) inch diameter pipe. Recommend providing four-inch air gap at the top of the wall.
  
- f) Septic tanks shall be watertight and constructed of sound and durable materials that are not subject to excessive corrosion or decay.
  - i. All septic tanks must be watertight. Two methods of ensuring tanks are watertight shall be either vacuum testing or water pressure testing methods as follows:
    - a. Vacuum testing: Seal the empty tank and apply a vacuum to four (4) inches (100mm) of mercury. The tank is approved if 90% of vacuum is held for two (2) minutes.
    - b. Water testing: Seal tank; fill tank with water to outlet invert elevation, let stand for 24 hours. Refill the tank to outlet invert after 24-hour period is complete. Let the tank stand for 10 hours. The tank is approved if water level is held for 10-hour. Water pressure testing is recommended to be done onsite after installation.
  
- g) Inlets and outlets shall be constructed to the following standards:
  - i. At least one inlet and one outlet shall be provided through the appropriate end or sidewall of each tank.
  - ii. The recommended minimum liquid depth of a septic tank shall be 4 feet. In no case shall the liquid depth of a septic tank be less than 3 feet. The liquid depth is measured from the outlet invert to the bottom of the tank.
  - iii. The outlet invert shall be a minimum of three inches below the inlet invert. However, the Department recommends the outlet invert be at least six inches below the inlet invert.
  - iv. All outlet inverts of the septic tank shall be set at the same invert elevation.
  - v. It is recommended that inlet and outlet pipes or penetrations be connected to the tank with a watertight sealed flexible joint and the pipe gasket be fastened to the



pipe with stainless steel retractable clamp or other means of sealing approved by the Department.

- vi. Outlets shall be located at the maximum possible flow path from the inlet(s).
- h) Unless otherwise stated, tanks shall be designed based upon 10NYCRR, Appendix 75-A or NYSDEC "Design Standards For Intermediate Sized Wastewater Treatment Systems".

## 2. Concrete Septic Tank

- a) All precast septic tank components (i.e. slabs, domes, covers, etc.) shall be constructed of precast reinforced concrete and designed to be traffic bearing to meet the requirements of AASHTO H-20/HS-20 loading.
- b) There shall be a minimum 1-foot air space measured from the outlet invert(s) to the bottom of the septic tank top slab or dome.
- c) Precast concrete sections shall be sealed with one (1) - inch butyl rubber joint sealant, which conforms to ASTM C-990 (Latest Revision).
- d) All sewer pipes shall penetrate the vertical sidewall of the tank and may be sealed with grout or other means acceptable to the Department such as watertight sealed flexible joint and the pipe gasket fastened to the pipe with stainless steel retractable clamp(s). There shall be no penetrations within domes.
- e) The opening in the traverse wall shall be 8 inches in height and at least 24 inches wide. The center shall be 18 inches below the liquid level. There shall be a minimum of 4-inch air gap at the top of the traverse wall.
- f) All joints shall be sealed so that the tank is watertight. Tanks that are cast in place must be certified by a licensed professional engineer and, as a minimum, have the floor and walls monolithically poured.
- g) Whenever practical, concrete septic tanks shall not be located within groundwater. For installations that are placed within groundwater, the bottom and side portions, up to 18 inches above highest recorded groundwater elevation, of the septic tank shall be monolithically constructed. In cases where this is not practicable, the septic tank unit shall be waterproofed up to 18 inches above the highest recorded groundwater elevation and leak tested to ensure water tightness prior to operation.
- h) In cases where concrete tanks are installed in groundwater, the design professional shall submit buoyancy calculations to prove the weight of the tank (with or without anchoring or the addition of ballast) will be at least 1.5 times more than the weight of the water displaced. The buoyancy calculations shall be done using highest expected groundwater elevation with the tank empty. Soil cover on top of the septic tank shall not be considered when determining the amount of anchoring or ballast weight required.

- i) All concrete septic tanks shall be cylindrical and shall meet the following:
  - i. Pre-Cast Single Unit Septic Tank (Figure # 2)
    - a. The minimum outside diameter cylindrical septic tank shall be 8 feet and the maximum outside diameter shall be 12 feet.
    - b. The minimum recommended liquid depth of any cylindrical septic tank shall be 4 feet. Liquid depth is the effective depth of the tank below the outlet pipe.
    - c. Eight (8) foot diameter tanks shall have a maximum liquid depth of 5 feet.
    - d. Ten (10) foot diameter tanks shall have maximum liquid depth of 6 feet.
    - e. Twelve (12) foot diameter tanks shall have a maximum liquid depth of 7 feet.
    - f. There shall be a maximum number of three (3) outlet pipes from the septic tank. All outlet pipes shall be set at the same elevation.

- ii. Concrete Two Unit Septic Tank (Figure #3)

In addition to the requirements listed for pre-cast single unit septic tanks, two unit septic tanks shall require the following:

- a. Units shall be connected with three (3) - 8-inch diameter pipes placed such that the centerlines of the pipes are 18 inches below the liquid level of the tank. The three connecting pipes shall be spaced 20 inches on center. Each unit shall have the same diameter and liquid depth.

- iii. Concrete Multiple Unit Septic Tank (Figures #4 and #5)

In addition to the requirements listed for pre-cast single unit septic tanks, multiple unit septic tanks shall require the following:

- a. When three or more individual septic tanks are utilized within one system, they shall be placed on a common reinforced concrete slab at least 6 inches thick.
- b. All units shall be connected with two (2) – 8-inch diameter pipes placed such that the centerlines of the pipes are 18 inches below the liquid level of the tank. Each connecting pipe set shall be spaced 20 inches on centers.
- c. Each unit shall have the same diameter and liquid depth.

### 3. Non-Concrete Septic Tanks

- a) All septic tank components (i.e. slabs, domes, covers, etc.) shall be designed and installed to be traffic bearing to meet the requirements of AASHTO H-20/HS-20 loading. Non-concrete septic tanks may be approved by the Department on a case-by-

case basis to be non-traffic bearing provided acceptable means are provided to prevent vehicular traffic over the septic tank.

- b) At a minimum, non-traffic bearing non-concrete septic tanks must meet the loading of the International Association of Plumbing and Mechanical Officials (IAPMAO) “American National Standard for Prefabricated Septic Tanks” ANSI Z1000-2007 and any updates thereto. In addition, these tanks shall not be installed within three (3) feet of a driveway/roadway or parking area unless a permanent fence or other permanent traffic barrier is installed (such as curbs).
- c) Non-Concrete septic tanks should be factory assembled or assembled in the field/distribution facility by a certified representative of the septic tank manufacture.
- d) Each non-concrete septic tank shall be identified by the manufacturer with the following information permanently marked at the inlet end of the tank:
  - i. Manufacturer name or logo
  - ii. Capacity and number of openings
  - iii. The date manufactured
- e) Precast concrete risers shall not be permitted to be used on non-concrete septic tanks unless otherwise approved by the manufacturer of the septic tank.
- f) Whenever practical, non-concrete septic tanks shall not be located within groundwater or in areas where the groundwater level can rise to the level of the bottom of the tank(s) unless all of the following conditions are met:
  - i. The tank is manufactured to accommodate an anchoring system.
  - ii. The design professional submits buoyancy calculations.
  - iii. Calculations are submitted with highest expected/recorded ground water level.
  - iv. A safety factor of 1.5 must be provided. To provide a safety factor of 1.5 anchoring or additional ballast can be used. Soil cover on top of the septic tank shall not be considered when determining the amount of anchoring or ballast weight required.
  - v. Particular care must be taken during installation, bedding, and backfilling of these units to prevent damage to tank walls. The manufacturer's installation instructions shall be followed.
  - vi. All tanks should be sold by the manufacturer completely assembled. If, because of size, the tank is delivered to the site in sections, all joints shall be sealed with watertight gaskets.
  - vii. All tanks shall be tested for water tightness after installation using a method specified by the manufacturer and approved by the Department.

#### 4. Septic Tank Installation Standards

- a) All units shall be provided with two openings with a minimum diameter of 20 inches positioned over the inlet and outlet pipes.
- b) All concrete septic tank covers shall be heavy-duty, watertight, insect-proof, adjustable and locking cast iron frame and cover shall be installed at grade over each opening.
- c) Whenever possible all non-concrete tanks covers shall have heavy-duty, watertight, insect-proof, adjustable and locking cast iron frame and cover shall be installed at grade over each opening. In lieu of cast iron covers on non-concrete tanks, thermoplastic covers may be used provided that all of the following conditions are met:
  - i. Thermoplastic covers must be certified by a New York State Professional Engineer to meet AASHTO H-20/HS-20 loading requirements or the septic tank must be placed in a non-traffic area and be installed to prevent vehicular traffic/loads over the septic tank.
  - ii. Covers shall be set at finished grade, be locking, watertight, insect-proof, flat, skid proof, and be approved for sewage use.
  - iii. All thermoplastics covers must have UV protection.
  - iv. Covers shall have a non-skid finish. Self-lubricating plastics, such as polyethylene, shall not be considered non-skid without addition of non-skid coating.
  - v. Covers shall form a watertight seal with the top of the chimney/riser.
  - vi. At a minimum, covers shall be capable of withstanding a truck wheel load (36 square inches) of 2500 pounds for 60 minutes with a maximum vertical deflection of 1.5 inches.
  - vii. Covers to grade shall be locking or provided with tamper-resistant stainless steel fasteners and a tool for fastener removal. Tamper-resistant fasteners include recessed drives, such as hex, torx, and square. Fasteners that can be removed with common screwdrivers, such as slotted and Philips, or fasteners that can be removed with standard tools, such as pliers or crescent wrenches, are not considered tamper-resistant.
  - viii. To prevent tripping hazard, fasteners shall not extend above the surface of the lid.
  - ix. Covers shall not allow water to pond on them. Covers shall be flat, with no noticeable upward dome. A crown or dome of no more than 1/8th inch is allowable.

- x. If using a non-traffic bearing cover that weighs less than 60lbs then a secondary safety lid or device shall be provided.
- d) Extension Collars (chimneys/risers) may be used for the purpose of bringing the covers to grade provided that they are firmly affixed in place and are constructed of pre-cast concrete.
- e) Extension collars (chimney/risers) shall be at least 24 inches in diameter and shall not exceed 2 feet in height.
- f) Non-concrete septic tanks which cannot utilize pre-cast extension collars may be permitted to use non-precast extension collars provided all of the following conditions are met:
  - i. Non-precast chimneys must be certified by a New York State Professional Engineer to meet AASHTO H-20/HS-20 loading requirements or the septic tank must be placed in a non-traffic area and be installed to prevent vehicular traffic/loads over the septic tank.
  - ii. Risers shall be constructed of non-corrosive material and designed to be buried in soil.
  - iii. Risers shall have a minimum stiffness of 10 psi, when tested according to ASTM D2412. Risers shall be capable of withstanding a truck wheel load (36 square inches) of 2500 pounds for 60 minutes with a maximum vertical deflection of 0.5 inches.
  - iv. All attachment components shall be constructed of waterproof, non-corrosive materials, such as PVC, ABS, fiberglass, or stainless steel. Adhesives and sealants shall be waterproof, corrosion resistant and approved for the intended application.
  - v. The riser-to-tank connection shall be watertight and structurally sound. The riser-to-tank connection shall be capable of withstanding a vertical uplift to prevent riser separation due to tank settlement, frost heave, or accidental vehicle traffic over the tank.
- g) The top of the septic tank shall be located a maximum of 2.5 feet below grade.
- h) The outlet pipe(s) from the tank shall be provided with a drop tee extending eighteen inches into the liquid. The outlet(s) shall be located at the maximum flow path from the inlet(s).
- i) Septic tanks shall be installed in accordance with the manufacturer's recommendation. All septic tanks shall be installed at level in all directions (with a maximum tolerance in any direction of  $\pm\frac{1}{4}$  inch) on a minimum 3-inch bed of properly graded and compacted sand, which is free of rock, or pea gravel.

## XV. GREASE TRAP REQUIREMENTS

### 1. General Requirements

- a) All restaurants and/or food preparation establishments are required to install a grease trap for the kitchen or food preparation area. A grease trap is considered part of the equipment necessary to obtain a permit to operate a food establishment pursuant to Article 13 of the Suffolk County Sanitary Code. Grease traps should be cleaned and maintained on a regular basis in order to insure proper functioning and insect free performance.
- b) Grease traps shall be located below grade and outside the building preceding the septic tank or sewer line. Only discharges from the kitchen or food preparation areas may be piped to grease traps. Grease traps shall be located in areas that are easily accessible for routine inspection and maintenance. Refer to Section XI for additional siting requirements.
- c) The required capacity of grease traps shall be based on the kitchen design flow for a one-day period. The kitchen design flow can be calculated from Section IX of these standards. All grease traps shall be a minimum size of 1500 gallons.
- d) When multiple grease traps are needed, they must be installed in series with each succeeding unit having a liquid depth of 6 inches less than the preceding unit.
- e) Grease traps shall be constructed of concrete, fiberglass or high-density polyethylene in accordance with this standard, 10NYCRR, Appendix 75-A, and the NYS DEC "Design Standards For Intermediate Sized Wastewater Treatment Systems". The use of steel grease traps shall be prohibited.
- f) Grease traps shall be watertight and constructed of sound and durable materials that are not subject to excessive corrosion or decay.
  - i. Grease traps must be watertight. Two methods of ensuring tanks are watertight shall be either vacuum testing or water pressure testing methods as follows:
    - a. Vacuum testing: Seal the empty tank and apply a vacuum to four (4) inches (100mm) of mercury. The tank is approved if 90% of vacuum is held for two (2) minutes.
    - b. Water testing: Seal tank; fill tank with water to outlet invert elevation, let stand for 24 hours. Refill the tank to the outlet invert after the 24-hour period is complete. Let the tank stand for an additional 10-hour period. The tank is approved if water level is held for the 10-hour period. Water pressure testing is recommended to be done onsite after installation.
- g) Inlets and outlets shall be constructed to the following standards:
  - i. At least one inlet and one outlet shall be provided through the appropriate end

or sidewall of each tank.

- ii. The recommended minimum liquid depth of a grease trap shall be 5-feet. In no case shall the liquid depth of a grease trap be less than 3- feet. The liquid depth is measured from the outlet invert to the bottom of the tank.
  - iii. The outlet invert shall be a minimum of 3-inches below the inlet invert. However, the Department recommends the outlet invert be at least 6-inches below the inlet invert.
  - iv. It is recommended that inlet and outlet pipes or penetrations be connected to the grease trap with a watertight sealed flexible joint and the pipe gasket be fastened to the pipe with stainless steel retractable clamp or other means of sealing approved by the Department.
  - v. Outlets shall be located at the maximum possible flow path from the inlet.
- h) Unless otherwise stated, grease traps shall be designed based upon 10NYCRR, Appendix 75-A or NYS DEC “Design Standards for Intermediate Sized Wastewater Treatment Systems”.

## 2. Concrete Grease Traps

- a) All precast grease trap components (i.e. slabs, domes, covers, etc.) shall be constructed of precast reinforced concrete and designed to be traffic bearing to meet the requirements of AASHTO H-20/HS-20 loading.
- b) There shall be a minimum 1-foot air space measured from the outlet invert(s) to the bottom of the grease trap top slab or dome.
- c) Precast concrete sections shall be sealed with one (1) - inch butyl rubber joint sealant, which conforms to ASTM C-990.
- d) All sewer pipes shall penetrate the vertical sidewall of the grease trap and may be sealed with grout or other means acceptable to the Department such as watertight sealed flexible joint and the pipe gasket fastened to the pipe with stainless steel retractable clamp(s). There shall be no penetrations within domes.
- e) All joints shall be sealed so that the tank is watertight. Grease traps that are cast in place must be certified by a licensed professional engineer and, as a minimum, have the floor and walls monolithically poured.
- f) The base section of all units (bottom slab and minimum of 1 foot of sidewall) shall be monolithically cast.
- g) Whenever practical, concrete grease traps shall not be located within groundwater. For installations that are placed within groundwater, the bottom and side portions, up to 18 inches above highest recorded groundwater elevation, of the grease trap shall be

monolithically constructed. In cases where this is not practicable, the grease trap unit shall be waterproofed up to 18 inches above the highest recorded groundwater elevation and leak tested to ensure water tightness prior to operation.

- h) In cases when concrete grease trap is installed in groundwater, the design professional shall submit buoyancy calculations to prove the weight of the tank (with or without anchoring or the addition of ballast) will be at least 1.5 times more than the weight of the water displaced. The buoyancy calculations shall be done using highest expected groundwater elevation with the tank empty. Soil cover on top of the septic tank shall not be considered when determining the amount of anchoring or ballast weight required.
- i) All concrete grease traps shall be cylindrical and shall meet the following:
  - i. Single Unit Grease Trap (Figure #6)
    - a. The minimum outside diameter cylindrical grease trap shall be 8 feet and the maximum outside diameter shall be 12 feet.
    - b. The liquid depth shall be a minimum of 5 feet and shall not exceed 7 feet depending upon diameter.
  - ii. Multiple Unit Grease Trap (Figure #7)
    - a. The minimum outside diameter cylindrical grease trap shall be 10 feet and the maximum outside diameter shall be 12 feet.
    - b. The liquid depth shall be a minimum of 5 feet and shall not exceed 7 feet depending upon diameter.
    - c. Each unit shall have the same diameter.
    - d. Units shall be connected in series by utilizing one 6-inch diameter drop tee pipe.
    - e. There shall be a 6-inch drop between the inlet and outlet pipes of each unit. Each succeeding unit shall have a liquid depth of 6 inches less than the preceding unit.

### 3. Non-Concrete Grease Traps

- a) All grease trap components (i.e. tanks, extension collars, covers, etc.) shall be designed and installed to be traffic bearing to meet the requirements of AASHTO H-20/HS-20 loading. Non-concrete grease traps may be approved by the Department on a case-by-case basis to be non-traffic bearing provided acceptable means are provided to prevent vehicular traffic over the grease trap.
- b) At a minimum, non-traffic bearing non-concrete grease traps must conform to the loading requirements of the International Association of Plumbing and Mechanical



Officials (IAPMAO) “American National Standard for Prefabricated Septic Tanks” ANSI Z1000-2007 and any updates thereto. In addition, these tanks shall not be installed within three (3) feet of a driveway/roadway or parking area unless a permanent fence or other permanent traffic barrier is installed (such as curbs).

- c) Non-Concrete grease traps should be factory assembled or assembled in the field/distribution facility by a certified representative of the septic tank manufacturer.
- d) Each non-concrete grease trap shall be identified by the manufacturer with the following information permanently marked at the inlet end of the tank:
  - i. Manufacturer name or logo
  - ii. Capacity and number of openings
  - iii. The date manufactured
- e) Precast concrete risers shall not be permitted to be used on non-concrete grease traps unless otherwise permitted by the manufacturer of the unit.
- f) Whenever practical, non-concrete grease traps shall not be located within groundwater or in areas where the groundwater level can rise to the level of the bottom of the tank(s) unless all of the following conditions are met:
  - i. The grease trap is manufactured to accommodate an anchoring system.
  - ii. The design professional submits buoyancy calculations.
  - iii. Calculations are submitted with highest expected/recorded ground water level.
  - iv. A safety factor of 1.5 must be provided. To provide a safety factor of 1.5 anchoring or additional ballast can be used. Soil cover on top of the septic tank shall not be considered when determining the amount of anchoring or ballast weight required.
  - v. Particular care must be taken during installation, bedding, and backfilling of these units so as to prevent damage to tank walls. The manufacturer's installation instructions shall be followed.
  - vi. All tanks should be sold by the manufacturer completely assembled. If, because of size, the tank is delivered to the site in sections, all joints shall be sealed with watertight gaskets.
  - vii. All tanks shall be tested for water tightness after installation using a method specified by the manufacturer and approved by the Department.

#### 4. Grease Trap Installation Requirements

- a) All units shall be provided with two openings with a minimum diameter of 20 inches positioned over the inlet and outlet pipes.

- b) All concrete grease traps covers shall be heavy-duty, watertight and insect-proof adjustable and locking cast iron frame and cover shall be installed at grade over each opening.
- c) Whenever possible all non-concrete grease trap covers shall have heavy-duty, watertight and insect-proof adjustable and locking cast iron frame and cover shall be installed at grade over each opening. In lieu of cast iron covers on non-concrete grease traps, thermoplastic covers may be used provided all of the following conditions are met:
  - i. Thermoplastic covers must be certified by a New York State Professional Engineer to meet AASHTO H-20 loading requirements or the grease trap must be placed in a non-traffic area and be installed to prevent vehicular traffic/loads over the grease trap.
  - ii. Covers shall be set at finished grade, be locking, watertight, insect-proof, flat, skid proof, and be approved for sewage use.
  - iii. All thermoplastics covers must have UV protection.
  - iv. Covers shall have a non-skid finish. Self-lubricating plastics, such as polyethylene, shall not be considered non-skid without addition of non-skid coating.
  - v. Covers shall form a watertight seal with the top of the chimney/riser.
  - vi. At a minimum, covers shall be capable of withstanding a truck wheel load (36 square inches) of 2500 pounds for 60 minutes with a maximum vertical deflection of 1.5 inches.
  - vii. Covers to grade shall be locking or provided with tamper-resistant stainless steel fasteners and a tool for fastener removal. Tamper-resistant fasteners include recessed drives, such as hex, torx, and square. Fasteners that can be removed with common screwdrivers, such as slotted and Philips, or fasteners that can be removed with standard tools, such as pliers or crescent wrenches, are not considered tamper-resistant.
  - viii. To prevent tripping hazard, fasteners shall not extend above the surface of the lid.
  - ix. Covers shall not allow water to pond on them. Covers shall be flat, with no noticeable upward dome. A crown or dome of no more than 1/8th inch is allowable.
  - x. If using a non-traffic bearing cover that weighs less than 60lbs then a secondary safety lid or device shall be provided.

- d) Extension Collars (chimneys/risers) may be used for the purpose of bringing the covers to grade provided that they are firmly affixed in place and be pre-cast concrete.
- e) Extension collars (chimney/risers) shall be at least 24 inches in diameter and shall not exceed 2 feet in height.
- f) Non-precast grease traps which cannot utilize pre-cast extension collars may be permitted to use non-precast extension collars provided all of the following conditions are met:
  - i. Non-precast chimneys must be certified by a New York State Professional Engineer to meet AASHTO H-20 loading requirements or the grease trap must be placed in a non-traffic area and be installed to prevent vehicular traffic/loads over the grease trap.
  - ii. Risers shall be constructed of non-corrosive material and designed to be buried in soil.
  - iii. Risers shall have a minimum stiffness of 10 psi, when tested according to ASTM D2412. Risers shall be capable of withstanding a truck wheel load (36 square inches) of 2500 pounds for 60 minutes with a maximum vertical deflection of 0.5 inches.
  - iv. All attachment components shall be constructed of waterproof, non-corrosive materials, such as PVC, ABS, fiberglass, or stainless steel. Adhesives and sealants shall be waterproof, corrosion resistant and approved for the intended application.
  - v. The riser-to-tank connection shall be watertight and structurally sound. The riser-to-tank connection shall be capable of withstanding a vertical uplift to prevent riser separation due to tank settlement, frost heave, or accidental vehicle traffic over the tank.
- g) The top of the grease trap shall be located a maximum of 2.5 feet below grade.
- h) Grease traps shall be installed in accordance with the manufacturer's recommendation. All grease traps shall be installed at level in all directions (with a maximum tolerance in any direction of  $\pm\frac{1}{4}$  inch) on a minimum 3-inch bed of properly graded and compacted sand, which is free of rock or pea gravel.
- i) The outlet pipe(s) from each grease trap unit shall be 6 inch in diameter to the inlet of the septic tank or sewer main. Each outlet shall be provided with a 6-inch diameter drop tee extending to 1 foot above the bottom of the tank. The outlet(s) shall be braced as required and located at the maximum practicable distance from the inlet.

## 5. Exceptions

While the requirement to install a grease trap at establishments served by community sewers shall not be waived, the design, location, capacity and construction details for the unit shall be determined by the appropriate sewer authority.

## **XVI. INNOVATIVE AND ALTERNATIVE ONSITE WASTEWATER TREATMENT SYSTEM (I/A OWTS)**

### 1. General Requirements

- a) Only I/A OWTS technologies approved for Experimental, Pilot, Provisional, or General Use in accordance with the Department's "Standards Promulgated Under Article 19 for Approval and Management of Innovative and Alternative Onsite Wastewater Treatment Systems" may be proposed for installation and use on parcels as a means of sewage disposal.
- b) The installer must hold a current Liquid Waste License pursuant to Suffolk County Code Chapter 563, Article VII (Septic Industry Businesses) and the proper Liquid Waste License endorsement as an Innovative and Alternative Treatment System Installer through the Suffolk County Department of Labor, Licensing and Consumer Affairs. The Department of Labor, Licensing, and Consumer Affairs maintains a list of licensed I/A OWTS Maintenance Providers.
- c) All I/A OWTS must be registered with the Department in accordance with Article 19 of the Suffolk County Sanitary Code prior to the Department granting certification of completed construction of "as built" plans.
- d) An executed Operation and Maintenance Contract between a Maintenance Provider and Property Owner must be submitted to the Department prior to approval of the I/A OWTS registration by the Department in accordance with Article 19 of the Suffolk County Sanitary Code. For properties containing multiple structures such as a condominium complex, apartment complex, industrial complex, or office complex, a single entity must maintain the Operation and Maintenance Contract for the I/A OWTS, such as a homeowner's association or an individual property owner.
- e) All installed I/A OWTS are required to have an initial 3-year warranty and operation and maintenance service contract. After the initial 3-year operation and maintenance service contract has expired, property owners are expected to maintain an operation and maintenance contract in accordance with Article 19 of the Suffolk County Sanitary Code.
- f) All installed I/A OWTS are required to be sampled in accordance with the Department's "Standards Promulgated Under Article 19 for Approval and Management of Innovative and Alternative Onsite Wastewater Treatment Systems".
- g) The I/A OWTS treatment unit consisting of the treatment tank, covers at grade, and chimneys/risers must be designed and installed to be traffic bearing meeting AASHTO

H-20 or HS-20 loading. In lieu of meeting the traffic bearing requirements, the I/A OWTS can be installed in an area not accessible to vehicular traffic with the installation of adequate protection demonstrated to the Department to prevent vehicles from being placed on top of the structure. Such protection can be in the form of a fence, bollards, etc.

- h) When an I/A OWTS is installed to serve a multi-tenant building and/or complex the I/A OWTS shall be installed with an alarm dialer capable of calling the property owner and O&M provider in the event of an alarm or emergency.
- i) When an I/A OWTS is installed to serve a multi-tenant building and/or complex the I/A OWTS must be designed to function during power outages (i.e. in-place generator with automatic transfer switch, portable generator with manual transfer switch, I/A OWTS can flow through by gravity during outages, etc.).
- j) When an I/A OWTS requires a vent, the unit shall be vented to the roof of the building being served. Vent pipes shall extend a minimum of 6 inches above the roofline and the top of the vent shall have a minimum horizontal separation of 12 inches to the sloped portion of the roof. In cases where it is not practical to vent the system to the roof of the building, a vent pipe may be piped to the exterior side of the building and terminate a minimum of 18 inches above grade (Note that sites subject to FEMA regulations may have to extend the vent pipe more than 18 inches above grade). These vent pipes shall be located a minimum of 3 feet from any window or doorway and must terminate with a carbon filter device. All vent pipes must have a minimum diameter of 2 inches.
- k) Installation and use of the I/A OWTS must conform to the Department's approved I/A OWTS guidance document prepared in accordance with the standards for "Approval and Management of Innovative and Alternative Onsite Wastewater Treatment Systems.", which may include alternate construction methods and installation requirements, which may differ from this standard.

## 2. I/A OWTS Minimum Design Requirements

- a) The treatment capacity shall be based on the design sewage flow rates stated in Table 1. In some cases the Department may request that the I/A OWTS be designed based on the sewage flow rates and anticipated loading of nitrogen, BOD, and total suspended solids of the facilities to be served by the I/A OWTS.
- b) I/A OWTS must meet the minimum separation distances stated in Table 2 or approved separation distances stated in the Department's approved I/A OWTS guidance document prepared in accordance with the Standards for "Approval and Management of Innovative and Alternative Onsite Wastewater Treatment Systems."
- c) I/A OWTS tanks shall be constructed of precast concrete, fiberglass, polyethylene, polypropylene, thermoplastics, or other materials in accordance with Department standards, 10NYCRR, Appendix 75-A, or NYS DEC requirements. The use of steel tanks is prohibited.

- d) When an I/A OWTS requires a septic tank for pretreatment the septic tank shall be designed in accordance with section XIV of this standard. The capacity of the septic tank shall be in accordance with the manufacturer or design professional recommendations.
- e) When an I/A OWTS is installed to serve an establishment requiring a grease trap, grease traps shall be designed in accordance with section XV of this standard, and a redundant grease trap is recommended to be installed in series. In addition, all fryer oil being emptied from frying equipment should not be discharged into the sanitary and/or kitchen plumbing system.
- f) Unless otherwise specified, the leaching structure/system that follows an I/A OWTS shall be designed in accordance with section XVII of this standard.
- g) At a minimum, all I/A OWTS treatment tanks shall have 20-inch covered access openings to grade located over the inlet and outlet. At a minimum, covers shall be either 20-inch diameter watertight and insect-proof locking heavy-duty cast iron covers or thermoplastic covers at final grade (see paragraph 4 of this section for further requirements).
- h) Garbage grinders shall not be permitted when an I/A OWTS is utilized as means of sewage disposal. In addition, water softeners shall not discharge into an I/A OWTS. The Department recommends water softener backwash should be connected to a separate onsite drywell acceptable to the Town or Village Building Department requirements.
- i) I/A OWTS tanks shall be watertight and constructed of sound and durable materials that are not subject to excessive corrosion or decay.
  - i. All tanks must be watertight. Two methods of ensuring tanks are watertight shall be either vacuum testing or water pressure testing methods as follows:
    - a. Vacuum testing: Seal the empty tank and apply a vacuum to four (4) inches (100mm) of mercury. The tank is approved if 90% of vacuum is held for two (2) minutes.
    - b. Water testing: Seal tank; fill tank with water to outlet invert elevation, let stand for 24 hours. Refill the tank to the outlet invert after the 24-hour period is complete. Let the tank stand for an additional 10-hour period. The tank is approved if water level is held for the 10-hour period. Water pressure testing is recommended to be done onsite after installation.

### 3. I/A OWTS Tank Construction Material Requirements

- a) Concrete Tanks
  - i. Pre-cast concrete sections shall be sealed with one (1) inch butyl rubber joint

- sealant, which conforms to ASTM C-990.
  - ii. All sewer pipes shall penetrate the vertical sidewall of the tank and shall be sealed with grout or other means acceptable to the Department such as watertight sealed flexible joint and the pipe gasket fastened to the pipe with stainless steel retractable clamp(s).
  - iii. All joints shall be sealed so that the tank is watertight. See section XVI paragraph B.9. Tanks that are cast in place require prior approval from the Department and must be certified by a Licensed Professional Engineer. At a minimum, the floor and walls of a concrete tank must be monolithically poured.
  - iv. Whenever practical, concrete I/A OWTS shall not be located within groundwater. For installations that are placed within groundwater, the bottom and side portions, up to 18 inches above highest recorded/expected groundwater elevation, of the I/A OWTS unit shall be monolithically constructed. In cases where this is not practicable, the I/A OWTS unit shall be water-proofed up to 18 inches above the highest recorded /expected groundwater elevation and leak tested to ensure tightness prior to operation.
  - v. In cases when concrete tanks are installed in groundwater, the design professional shall submit buoyancy calculations to prove the weight of the tank (with or without anchoring or the addition of ballast) will be at least 1.5 times more than the weight of the water displaced. The buoyancy calculations shall be done using highest expected/recorded groundwater elevation with the tank empty. Soil cover on top of the septic tank shall not be considered when determining the amount of anchoring or ballast weight required.
- b) Non-Concrete Tanks
- i. At a minimum, non-traffic bearing non-concrete I/A OWTS tanks must meet the loading of the International Association of Plumbing and Mechanical Officials (IAPMAO) “American National Standard for Prefabricated Septic Tanks” ANSI Z1000-2007 material requirements and any updates thereto. In addition, these tanks shall not be installed within three (3) feet of a driveway/roadway or parking area unless a permanent fence or other permanent traffic barrier is installed (such as curbs).
  - ii. Whenever practical, non-concrete I/A OWTS shall not be located within groundwater or in areas where the groundwater level can rise to the level of the bottom of the tank(s) unless all of the following conditions are met:
    - a. The tank is manufactured to accommodate an anchoring system.
    - b. The design professional submits buoyancy calculations.
    - c. Calculations are done with highest expected/recorded ground water level.
    - d. A safety factor of 1.5 is included in the design. To provide a safety factor of 1.5 anchoring or additional ballast can be used. Soil cover on top of the septic tank shall not be considered when determining the amount of anchoring or ballast weight required.

- e. Particular care must be taken during installation, bedding, and backfilling of these units to prevent damage to tank walls. The manufacturer's installation instructions shall be followed.
- f. All tanks should be sold by the manufacturer completely assembled. If, because of size, the tank is delivered to the site in sections, all joints shall be sealed with watertight gaskets.
- g. All tanks shall be tested for water tightness after installation using a method specified by the manufacturer and approved by the Department.

#### 4. I/A OWTS Installation Standards

- a) All I/A OWTS units shall be provided with a minimum of two openings with a minimum diameter of 20 inches positioned over the inlet and outlet pipes of the tank(s).
- b) All concrete I/A OWTS unit covers shall be heavy-duty, watertight, insect-proof, adjustable, and locking cast iron frame and cover shall be installed at grade over each opening.
- c) Whenever possible all non-concrete I/A OWTS covers shall have heavy-duty, watertight, insect-proof, adjustable and a locking cast iron frame and cover shall be installed at grade over each opening. In lieu of cast iron covers on non-concrete I/A OWTS, thermoplastic covers may be used provided all of the following conditions are met:
  - xi. Thermoplastic covers must be certified by a New York State Professional Engineer to meet AASHTO H-20 loading requirements or the I/A OWTS units must be placed in a non-traffic area and be installed to prevent vehicular traffic/loads over the I/A OWTS unit.
  - xii. Covers shall be set at finished grade, be locking, watertight, insect-proof, flat, skid proof, and be approved for sewage use.
  - xiii. All thermoplastics covers must have UV protection.
  - xiv. Covers shall have a non-skid finish. Self-lubricating plastics, such as polyethylene, shall not be considered non-skid without addition of non-skid coating.
  - xv. Covers shall form a watertight seal with the top of the chimney/riser.
  - xvi. At a minimum, covers shall be capable of withstanding a truck wheel load (36 square inches) of 2500 pounds for 60 minutes with a maximum vertical deflection of 1.5 inches.
  - xvii. Covers to grade shall be locking or provided with tamper-resistant stainless steel fasteners and a tool for fastener removal. Tamper-resistant fasteners include recessed drives, such as hex, torx, and square. Fasteners that can be removed



- with common screwdrivers, such as slotted and Philips, or fasteners that can be removed with standard tools, such as pliers or crescent wrenches, are not considered tamper-resistant.
- xviii. To prevent tripping hazard, fasteners shall not extend above the surface of the lid.
  - xix. Covers shall not allow water to pond on them. Covers shall be flat, with no noticeable upward dome. A crown or dome of no more than 1/8th inch is allowable.
  - xx. If using a non-traffic bearing cover that weighs less than 60lbs then a secondary safety lid or device shall be provided.
- d) Extension Collars (chimneys/risers) may be used for the purpose of bringing the covers to grade provided that they are firmly affixed in place and be pre-cast concrete.
  - e) Extension collars (chimney/risers) shall be at least 24 inches in diameter and shall not exceed 2 feet in height.
  - f) Non-precast I/A OWTS which cannot utilize pre-cast extension collars may be permitted to use non-precast extension collars provided all of the following conditions are met:
    - i. Non-precast chimneys must be certified by a New York State Professional Engineer to meet AASHTO H-20 loading requirements or the grease trap must be placed in a non-traffic area and be installed to prevent vehicular traffic/loads over the grease trap.
    - ii. Risers shall be constructed of non-corrosive material and designed to be buried in soil.
    - iii. Risers shall have a minimum stiffness of 10 psi, when tested according to ASTM D2412. Risers shall be capable of withstanding a truck wheel load (36 square inches) of 2500 pounds for 60 minutes with a maximum vertical deflection of 0.5 inches.
    - iv. All attachment components shall be constructed of waterproof, non-corrosive materials, such as PVC, ABS, fiberglass, or stainless steel. Adhesives and sealants shall be waterproof, corrosion resistant and approved for the intended application.
    - v. The riser-to-tank connection shall be watertight and structurally sound. The riser-to-tank connection shall be capable of withstanding a vertical uplift to prevent riser separation due to tank settlement, frost heave, or accidental vehicle traffic over the tank.
  - g) Install I/A OWTS tanks according to manufacturer's recommendations. All applicable

recommendations provided by the manufacturer shall be implemented.

- h) The I/A OWTS tank shall be installed at level in all directions (with a maximum tolerance in any direction of +/- one quarter inch) on a minimum 3-inch thick bed of properly leveled and compacted sand (free from rocks) or pea gravel.
- i) I/A OWTS Tanks shall be provided with a single outlet. A distribution box/manhole or distribution leaching structure may be required for systems with multiple leaching structures unless an alternative design is approved by the Department.
- j) The top of the I/A OWTS shall not be located greater than 2.5 feet or less than one foot below final grade.

#### 5. Provisions for Sampling I/A OWTS

Each I/A OWTS must have a sampling point acceptable and accessible to the Department where composite and/or grab samples of the system effluent can be acquired by the Department, manufacturer, or third party that provide representative samples of the effluent discharge. In some cases, the Department may require the installation of a sampling manhole or other sampling structure. In those cases, sampling manholes or structures shall be designed according to the following:

- a) General Requirements:
  - i. At a minimum, all sampling manholes shall have 20-inch covered access openings to grade located. Covers shall be 20-inch diameter, heavy-duty, watertight and insect-proof locking cast iron or thermoplastic covers at final grade. All covers shall have a non-skid finish. Self-lubricating plastics, such as polyethylene, shall not be considered non-skid without the addition of non-skid coating.
  - ii. Extension Collars (chimneys or risers) may be used for the purpose of bringing the covers to grade provided that they are firmly affixed in place. .
  - iii. When sampling manholes are approved to be installed in a driveway or parking area, the manhole shall be designed to be traffic bearing to meet the requirements of AASHTO H-20 or HS-20 loading.
  - iv. The outlet invert elevation shall be a minimum of 0.1 foot below the inlet invert elevation.
  - v. Sampling manholes shall have an inside diameter of 2 feet or an inside area of 2 foot by 2 foot.
  - vi. There shall be a maximum retention depth below the outlet invert elevation of six inches.
  - vii. All sewer pipes penetrating the sampling manhole shall be accomplished with a

- viii. flexible rubber sleeve and stainless steel tightening devices.
      - viii. Maximum depth for sampling manhole shall be 4 feet.
      - ix. All manholes must be certified as watertight by manufacturer and/or the design professional
    - b) Concrete Sampling Manholes
      - i. Pre-cast sampling manholes must conform to section XVIII of this standard.
    - c) Non-Concrete Sampling Manholes
      - i. Fiberglass sampling manholes shall be constructed in accordance with ASTM D3753 (latest revision).
      - ii. High Density Polyethylene (HDPE) sampling manholes shall be constructed in accordance with ASTM F1759 (latest revision).
      - iii. These manholes shall not be installed in areas where the groundwater level can rise to the level of the bottom of the manhole(s) unless all of the following conditions are met:
        - a. The manhole shall be manufactured to accommodate an anchoring system.
        - b. The design professional submits buoyancy calculations.
        - c. Calculations shall be done with highest expected ground water level.
        - d. A safety factor of 1.5 is required. To provide a safety factor of 1.5 anchoring or additional ballast can be used. Soil cover on top of the septic tank shall not be considered when determining the amount of anchoring or ballast weight required.
    - d) Other Sampling Structures
      - i. Plans may be submitted with an alternative sampling structure(s) (e.g. sampling traps, etc.).
      - ii. Plans for use of an alternative sampling structure must be prepared by a Licensed Professional Engineer or Licensed Registered Architect.
      - iii. The design professional must ensure the sampling structure provides adequate retention and access for collection of samples (composite and grab samples). In addition, the sampling structure shall permit adequate flushing of the retention area.

## 6. Electrical Requirements

- a) Control Panels
  - i. The control panel box must be placed outside on a suitable pedestal near the

structure that it serves. Alternatively, the panel box may be mounted on an outside wall of the structure (preferably a utility room, and not a living space). Control panels must be located within a locking NEMA 4X rated enclosure. Other locations for mounting the panel box will be considered by the Department on a case-by-case basis and with I/A OWTS manufacturer approval.

- ii. The panel box must be within view of the system location to help facilitate operation and maintenance.
- iii. The control panel shall be placed at a comfortable height for access and in conformance with United States Federal Emergency Management Agency (FEMA) flood zone requirements
- iv. The panel shall meet National Electrical Manufacturers Association (NEMA) 4X specifications.
- v. The conduit must have appropriate seals to prevent gases and moisture from reaching the control panel or junction boxes. All underground electrical wiring for I/A OWTS shall be placed in conduit piping.
- vi. Each system shall be equipped with a functioning warning system, which will activate audible and visual alarms that can be readily seen and heard by the occupants of the building served. The Department recommends a telemetry device be installed to provide immediate remote alarm notification to the O&M provider covered by the O&M agreement (Note per Paragraph 1.J. of this section, multi-tenant buildings and/or complexes are required to have a telemetry device/alarm dialer installed).
- vii. Systems which are not designed to flow by gravity must be either equipped with a control panel with means of connecting a portable generator to operate the system during a power outage or connected to an in-place generator with automatic transfer switch.

b) Pumps, Blowers, Level Sensors, and Controls

- i. The electrical junction box serving the pump motor and floats must be watertight and located outside the I/A OWTS tank chamber.
- ii. Any blowers located outside of the I/A OWTS unit must be placed on a pad (concrete, plastic or fiberglass) and have a soundproof enclosure cover.
- iii. All pumps and float trees must be accessible and serviceable from access openings.
- iv. The floats shall be attached to a Schedule 40 PVC float tree that can be easily removed for service or adjustment. The floats shall not be attached to the force main.
- v. The Department shall observe the pump system operate through a normal

operating cycle. Testing the system without water is not acceptable.

- vi. Inspection for leakage of the force main fittings will be made during the pump test procedure.

## **XVII. LEACHING STRUCTURE/SYSTEM REQUIREMENTS**

### **1. General**

- a) Leaching structures are used as part of conventional subsurface or alternative sewage disposal system, I/A OWTS and on-site and community sewage treatment systems to infiltrate effluent into the surrounding soil.
- b) The bottom of any leaching structure shall be at least three feet above the highest expected/recorded groundwater elevation at the proposed system's location and at least two feet for shallow alternative systems (leaching pools, leaching galley, gravelless absorption trench systems and gravelless absorption bed systems) approved by the Department.
- c) Leaching structures/systems must be installed in areas that are easily accessible for routine inspection, maintenance, replacement or expansion. Refer to Section XI for additional requirements concerning the location of leaching structures.
- d) The bottom and sidewall area of the leaching structures shall be free of debris before backfilling.
- e) The minimum required system leaching area for leaching pools and leaching galleys designed in accordance with paragraphs B and D of this section shall be 300 sq.ft. and shall be designed to receive one full day's hydraulic design flow. All other leaching structure designs shall have a minimum leaching area designed based on 440gpd.
- f) Leaching pools or galleys installed in sand and gravel (defined by SP or SW by ASTM standards) shall be permitted to be designed with a maximum hydraulic leaching rate of 1.5 gal/sq.ft./day for Conventional Subsurface Sewage Disposal Systems or I/A OWTS.
- g) Leaching pools or galleys installed in sand and gravel (defined by SP or SW by ASTM standards) shall be permitted to be designed with a maximum hydraulic leaching rate of 5 gal/sq.ft./day for On-Site and Community Sewage Treatment Systems without positive filtration processes.
- h) Leaching pools or galleys installed in sand and gravel (defined by SP or SW by ASTM standards) shall be permitted to be designed with a maximum hydraulic leaching rate of 10 gal/sq.ft./day for On-Site and Community Sewage Treatment Systems with positive filtration processes.
- i) Gravelless Absorption Trench Systems and Other leaching structures/systems (other than leaching pools and leaching galleys) shall be designed in accordance with Section

XVII Paragraph 4 and 5 of this standard.

- j) Leaching structures designed in rows (e.g. leaching galleys, absorption trenches, etc.) shall be designed to be installed parallel with the ground contours to the greatest extent possible with the bottoms of the leaching structures installed as near level as possible. Abrupt changes in direction shall be avoided where possible.
- k) Unless otherwise stated, leaching structures/systems shall be designed based upon 10NYCRR, Appendix 75-A or NYSDEC “Design Standards For Intermediate Sized Wastewater Treatment Systems”.

## 2. Leaching Pool Design and Construction

### a) Design Leaching Area

Leaching pool systems shall be designed on the basis of sidewall area to receive one full day’s hydraulic design flow. The required sidewall leaching area is computed from the outside wall area below the inlet pipe for satellite pools and below the outlet pipe for distribution pools. The pool bottom area is not to be included in the leaching area computation.

### b) Leaching Pool Design and Construction Details (**Figure #8**)

- i. All leaching pools shall have an outside diameter of 8 feet or 10 feet.
- ii. When more than one leaching pool is used, all pools shall be the same size and depth, except the distribution pool, which may differ.
- iii. When a distribution pool is used, all outlet pipes shall be set at the same elevation and be at least 3 inches below the inlet pipe. All outlets shall be provided with an 18-inch drop tee.
- iv. The maximum permissible depth of a precast concrete leaching pool is 25 feet from finished grade. The minimum permissible effective depth of any leaching pool shall be 3 feet.
- v. All leaching pools (i.e. slabs, domes, covers, etc.) shall be constructed of precast reinforced concrete and designed to be traffic bearing to meet the requirements of AASHTO H-20 loading.
- vi. All leaching pools shall be provided with one opening with a minimum diameter of 20 inches. A heavy-duty, watertight, insect-proof, adjustable and locking cast iron frame and cover shall be installed at grade over each opening.
- vii. Extension Collars (chimneys) may be used for the purpose of bringing the cast iron covers to grade provided that they are firmly affixed in place. The extension collar (chimney) shall be of reinforced precast concrete at least 24 inches in diameter and shall not exceed 2 feet in height.

- viii. The top slab or dome of the leaching pool shall be located a maximum of 2.5 feet below grade.
  - ix. All sewer pipes shall penetrate the vertical sidewall of the leaching pool and shall be sealed with grout. There shall be no penetrations within domes.
- c) Leaching Pool Arrangement / Layout (**Figure #9**)
- i. A maximum of three (3) leaching pools is permitted to be piped directly from the septic tank.
  - ii. When four or more leaching pools are required, a distribution leaching pool or a distribution manhole shall be used to apportion the flow to the satellite leaching pools.
  - iii. A maximum of four satellite-leaching pools shall be piped from a distribution pool or manhole to form one leaching pool cluster.
  - iv. When more than five leaching pools are required, multiple leaching pool clusters shall be provided. The leaching pool clusters may be piped directly from the septic tank or from distribution pools or manholes as required.
  - v. When multiple clusters are utilized, each cluster shall be equipped with a gate or ball valve to allow for isolation and resting. Each valve shall be outfitted with a traffic bearing cover that is accessible for operation from grade.
- d) Installation Requirements
- i. Leaching pools shall be installed in clean sand (defined as SP or SW by ASTM standards).
  - ii. Unsuitable soils shall be removed and replaced with clean sand for a diameter 6 feet greater than the leaching pool (3-foot collar) extending down until a hydraulic connection is established with a minimum 6-foot stratum of acceptable material.
  - iii. The bottom and sidewall area of the leaching pools shall be free of debris before backfilling.

### 3. Leaching Galley Design and Construction

- a) Design Leaching Area
- i. Leaching galley systems shall be designed on the basis of sidewall area to receive one full day's hydraulic design flow. The required sidewall leaching area is computed from the outside wall area the leaching galley bottom area is not to be included in the leaching area computation.

- ii. The minimum effective depth of a leaching galley is 2ft. Leaching galleys with effective depths of less than 2ft but no less than 1ft may be designed in accordance with Section XVII Paragraph 4 of this standard.
- b) Leaching Galley Design and Construction Details (**Figure #10**)
- i. Leaching galleys shall have a length of 8.5 feet and width of 4.75.
  - ii. When more than one leaching galley is used, all leaching galleys shall be of nominally equal size.
  - iii. All leaching galleys (i.e. slabs, covers, etc.) shall be constructed of precast reinforced concrete and designed to be traffic bearing to meet the requirements of AASHTO H-20/HS-20 loading.
  - iv. All leaching galleys shall be provided with one opening with a minimum diameter of 20 inches. A heavy-duty, watertight, insect-proof, adjustable and locking cast iron frame and cover shall be installed at grade over each opening.
  - v. Extension Collars (chimneys) may be used for the purpose of bringing the cast iron covers to grade provided that they are firmly affixed in place. The extension collar (chimney) shall be of reinforced precast concrete at least 24 inches in diameter and shall not exceed 2 feet in height.
  - vi. The top slab or dome of the leaching galley shall be located a maximum of 2.5 feet below grade.
  - vii. All sewer pipes shall penetrate the vertical sidewall of the leaching galley and shall be sealed with grout.
- c) Leaching Galley Arrangement / Layout (**Figure #10**)
- i. Leaching galleys in the same row shall have a separation distance of 2 feet, and leaching galley rows shall have a separation distance of 4 feet between rows. Leaching galleys with an effective depth of greater than 4 feet shall be placed 8 feet apart.
  - ii. Rows shall not exceed 51 feet in length
  - iii. The leaching galleys shall be piped directly from the septic tank, I/A OWTS or a distribution structure.
  - iv. A maximum of four satellite leaching galley rows shall be piped from a distribution manhole.



- v. When multiple rows are utilized, each row shall be equipped with a gate or ball valve to allow for isolation and resting. Each valve shall be outfitted with a traffic bearing cover that is accessible for operation from grade.

d) Installation Requirements

- i. Leaching galleys shall be installed in clean sand (defined as SP or SW by ASTM standards).
- ii. Unsuitable soils shall be removed and replaced with clean sand for a 3-foot collar around the leaching galley structure extending down until a hydraulic connection is established with a minimum 6-foot stratum of acceptable material.
- iii. The bottom and sidewall area of the leaching galleys shall be free of debris before backfilling.

4. Gravelless Absorption Trench System Design and Construction

- a) Open-bottom gravelless chambers and gravelless geotextile sand filter systems approved by the Department; or listed in the NYSDOH “Residential Onsite Wastewater Treatment Systems Design Handbook,” Appendix C may be used for Other Construction Projects.

- i. Open-bottom gravelless chambers and gravelless geotextile sand filter permitted under this section with direct discharge of septic tank effluent to the leaching structures/system under paved or otherwise compacted surfaces are not recommended. If these leaching structures/systems are required to be installed under a paved or otherwise compacted surface the Department recommends the use of an I/A OWTS prior to the leaching structures/system.
- ii. All leaching structures/systems shall be designed to be traffic bearing to meet the requirements of AASHTO H-20 or HS-20 loading. If this cannot be provided, then the Department may permit these leaching structures to be installed in non-paved areas or areas with non-compacted surfaces if adequate means are provided to protect the leaching structure/system from any vehicular traffic.
- iii. Trench leaching systems shall have a total minimum length based on percolation rate for the site and application rates stated in **Table 3**. The trench length required shall be based on 2ft wide trenches with 4ft between trenches. The maximum trench length shall be 60ft. Each trench should be the same length. A reduction in trench length may be granted based on the following:
  - a. A 33% reduction in total trench length when the leaching structures follow an I/A OWTS
  - b. A 25% reduction in total trench length when using gravelless chambers meeting all of the following criteria:

- Open-bottom infiltration area of 1.6 square feet per linear foot.
  - Volumetric capacity of 7.5 gallons per linear foot.
  - Open sidewall area for aeration and infiltration.
- c. Use of 6 square feet per linear foot when using gravelless geotextile sand filter systems meeting all of the following criteria:
- Unit minimum width of 3 feet
  - Unit minimum storage capacity of 12 gallons per linear foot
  - A minimum 6 inches of sand must be installed below and on the sides of each unit (Sand that meets ASTM specification C33)
- d. Note the reductions for 25% and 6 square feet per linear foot cannot be taken when taking the 33% reduction due to the use of an I/A OWTS.
- iv. Trench leaching systems must be installed according to manufacturer's recommendations and adhering to this standard.
- v. Effluent must be discharged to the trench system by gravity from a septic tank, I/A OWTS unit, or manhole/distribution box.
- vi. Inspection ports with covers to grade must be installed at the mid-point of each trench, and clean-outs to grade should be installed at the end of each trench for maintenance purposes.
- vii. An effluent filtering mechanism or effluent filter with a label indicating compliance with NSF Standard 46 or equivalent must be installed directly preceding the leaching structure in the septic tank discharge pipe to the leaching system. If an I/A OWTS is to be utilized, an effluent filtering mechanism or effluent filter may be required on the discharge pipe of the unit at the discretion of the Department.

#### A. Gravelless Absorption Bed Systems Design and Construction

- a) Any open-bottom gravelless chamber and gravelless geotextile sand filter systems approved by the Department; or listed in the NYSDOH "Residential Onsite Wastewater Treatment Systems Design Handbook," Appendix C may be utilized to design the absorption bed system.
- b) Absorption beds permitted under this section with direct discharge of septic tank effluent to the leaching structures/system under paved or otherwise compacted surfaces is not recommended. If these leaching structures/systems are required to be installed under a paved or otherwise compacted surface the Department recommends

the use of an I/A OWTS prior to the leaching structures/system.

- c) All leaching structures/systems shall be designed to be traffic bearing to meet the requirements of AASHTO H-20 or HS-20 loading. If this cannot be provided, then the Department may permit these leaching structures to be installed in non-paved areas or areas with non-compacted surfaces if adequate means are provided to protect the leaching structure/system from any vehicular traffic.
- d) The absorption bed systems shall have a total minimum area based on percolation rate for the site and application rates stated in **Table 3**. A maximum of 4ft spacing is permitted between the rows of leaching structure units (Note if using a gravelless geotextile sand filter product then the unit must have a width of 3ft, the unit must have a storage capacity of 12 gallons per linear foot, and the unit must have a minimum 6 inches of sand must be installed below and on the sides of each unit that meets ASTM specification C33). The maximum width of the trench shall be 20ft with a maximum length of 60ft.
- e) Effluent must be discharged to the absorption beds by gravity from a septic tank, I/A OWTS unit, or manhole/distribution box.
- f) Absorption bed systems must be installed according to manufacturer's recommendations and adhering to this standard.
- g) Inspection ports with covers to grade must be installed at the mid-point of each row of leaching units, and clean-outs to grade should be installed at the end of each trench for maintenance purposes.
- h) An effluent filtering mechanism or effluent filter with a label indicating compliance with NSF Standard 46 or equivalent must be installed directly preceding the leaching structure in the septic tank discharge pipe to the leaching system. If an I/A OWTS is to be utilized, an effluent filtering mechanism or effluent filter may be required on the discharge pipe of the unit at the discretion of the Department.

## **XVIII. MANHOLE REQUIREMENTS**

### **1. General**

Manholes are used as part of a sewage disposal and collection systems to distribute equal volumes of sewage, to allow for access, or to collect and re-distribute sewage.

### **2. Location**

- a) Manholes shall be provided on gravity sewer lines wherever there is a grade change or alignment change further than 10 feet from building foundations as measured along the pipe.
- b) Manholes shall be provided on gravity sewer lines at intervals not exceeding 400 feet.

- c) Manholes shall be provided at the junctions and at the ends of lateral or main sewer lines.
- d) Building sewer connections shall not be piped directly to a collection system manhole, but shall be connected to the main line via a wye connection.

### 3. Design and Construction Details

- a) All manholes (i.e. slabs, covers, etc.) shall be constructed of precast reinforced concrete and designed to be traffic bearing to meet the requirements of AASHTO H-20 loading.
- b) All manholes shall be constructed in accordance with ASTM C-478 (latest revision).
- c) All manholes shall be provided with an opening with a minimum diameter of 20 inches. A heavy-duty, watertight, insect-proof, adjustable and locking cast iron frame and cover shall be installed at grade over each opening.
- d) Extension Collars (chimneys) may be used for the purpose of bringing the cast iron covers to grade if they are firmly affixed in place. The extension collar (chimney) shall be of reinforced precast concrete at least 24-inches in diameter and shall not exceed 2 feet in height.
- e) The top slab of the manhole shall be located a maximum of 2.5 feet below grade.
- f) The base section of all manholes (bottom slab and minimum of 1 foot of sidewall) shall be monolithically cast.
- g) Precast concrete sections shall be sealed with one (1) - inch butyl rubber joint sealant, which conforms to ASTM C-990.
- h) The bottom of all manholes shall be coved or benched. The bench shall be the same width as the diameter of the pipe and shall extend upward at least three-quarters of the diameter of the pipe.
- i) All sewer pipes penetrating the manhole shall be accomplished with a cast- in place flexible rubber sleeve that conforms to ASTM C-923 and stainless steel tightening devices. For cases where a new penetration is being made into an existing manhole, a link seal may be substituted for the rubber boot.
- j) If the manhole is more than four feet in depth, manhole steps shall be provided every twelve (12) inches. The steps shall be constructed of copolymer polypropylene coated 2-inch steel reinforcing bar. The access opening shall be provided over the manhole steps.
- k) Whenever practical, manholes shall not be located in groundwater. For installations that are placed in groundwater, the bottom and side portion, up to 18 inches above the highest recorded groundwater elevation, of the manhole shall be monolithically

constructed. In cases where this is not practicable, the manhole shall be waterproofed up to 18 inches above the highest recorded groundwater elevation and leak tested to ensure tightness prior to operation. Maximum permissible leak rate is  $\frac{1}{4}$  inch in 8 hours.

#### 4. Types of Manholes

Manholes can be broken into four general categories. In addition to the items stated in paragraphs 1, 2, and 3 of this section above, each category shall conform to the following requirements:

- a) Access/Junction Manhole (Figure #11)
  - i. Access/junction manholes shall have a minimum inside diameter of 4 feet.
  - ii. For pipe diameters of 24 inches or greater, the minimum inside diameter of the manhole shall be 5 feet.
  - iii. A minimum drop of 0.1 foot shall be provided between the inlet and lowest outlet invert elevation.
  - iv. The maximum change in elevation between the inlet and outlet invert shall be no greater than 2 feet.
- b) Drop Manhole (Figure #12)
  - i. All drop manholes shall have a minimum inside diameter of 5 feet
  - ii. A drop manhole is required to be provided when the difference in elevation between the inflow and outflow sewer line is greater than 2 feet.
  - iii. The drop pipe shall be securely attached to the sidewall of the manhole with stainless steel straps.
- c) Distribution Manhole (Figure #13)
  - i. All outlets from the distribution manhole shall be set at the same elevation.
  - ii. A minimum drop of 0.1 foot shall be provided between the inlet and outlet invert elevations.
- d) Sampling Manhole (Figure #14)
  - i. Dimensions for sampling manholes shall be 2 foot by 2 foot.
  - ii. Maximum depth for sampling manhole shall be 4 feet.

- iii. A minimum drop of 0.1 foot shall be provided between the inlet and outlet invert elevations.
- iv. A 12-inch deep sample retention area shall be provided below the outlet invert elevation.

## **XIX. GRAVITY SEWER LINE REQUIREMENTS**

### **1. General Sewer Line Requirements**

- a) Gravity sewer lines and fittings shall meet or exceed ASTM standard D-3034 for PVC sewer pipe with a minimum SDR 35 rating, unless otherwise indicated.
- b) PVC pipe and fittings shall be provided with integral bells and spigots and rubber sealing rings. The sealing rings shall meet the requirements of ASTM standard F-477. All sewer lines shall be straight, and couplings shall be securely installed and be watertight.
- c) All gravity sewer lines shall have a minimum diameter of four (4) inches and be buried below grade.
- d) Where practical, gravity sewer lines shall not be installed in groundwater. For installations that are placed in groundwater, the sewer piping shall be constructed of pressure rated piping and tested to ensure tightness prior to operation. Maximum permissible leak rate is  $\frac{1}{4}$  inch in 8 hours.

### **2. Internal Building Plumbing**

- a) Internal building plumbing shall be designed in accordance with applicable building codes and is outside the jurisdiction of the Department.
- b) It is the preference of the Department that all individually owned buildings, residences, or premises be plumbed separately and serviced with an independent house connection to the exterior sanitary services.
- c) The use of common house connections shall be permitted if the internal plumbing is designed to accommodate multiple sewer connections in accordance with good engineering practice and applicable building codes. In addition, restrictive covenants shall be placed upon the property notifying the owner and/or homeowners association of their responsibility for the operation and maintenance of the internal sewer appurtenances; including, but not limited to, the repair, replacement, and cleaning of the internal piping within the structure.

### **3. House Connections**

- a) A house connection is defined as the portion of the gravity sewer line, which extends from the face of the building to the sewage disposal or sewer system.

- b) There shall be a minimum two-foot length of cast-iron sewer line extending through the foundation.
- c) House connections shall have a minimum diameter of 4 inches, unless otherwise noted.
- d) House connections serving two or more commercial or multiple residential units shall have a minimum diameter of 6 inches.
- e) House connections shall have a minimum pitch of  $\frac{1}{4}$  inch per foot.
- f) Slip ring connectors of the proper type shall be used at the cast iron joint. If required, flexible PVC coupling with stainless steel bands may be used to connect cast iron pipe to PVC house Connections. The flexible coupling and bands shall conform to ASTM C1173. 4 inch by 4 inch flexible rubber couplings are not permitted. Consult the Department when attempting to couple to a pre-existing, non-conforming building house connection.
- g) All house connections shall be provided with a clean-out at the exterior face of the building.
- h) Cleanouts are required every 75 feet along the length the house connection. Refer to Figure #15.
- i) House connections shall be straight. There shall be no bends in sewer lines to the septic tank, I/A OWTS, or grease trap. If bends are unavoidable, then the following additional criteria shall apply:
  - i. Cleanouts at each directional change are required.
  - ii. Use of a single 90-degree fitting with clean-out is prohibited.
  - iii. If a directional change greater than 45 degrees is required, a minimum of 5-foot length of pipe shall be installed between fittings.
  - iv. Directional changes should be limited to no more than 90-degrees and consisting of no more than two fittings located within 10 ft. of the building foundation unless proven absolutely necessary.
    - 1. Manholes may be substituted for directional changes with clean-outs for bends located greater than 10 ft. from the building foundation.

#### 4. Sewer Main / Lateral Sewer Requirements

- a) Sewer main and lateral sewers shall have a uniform slope and be laid with a straight alignment, without bends. When required, approved manholes may be utilized where sewers change direction or slope.

- b) House or building sewers shall be connected to main or lateral sewers with approved wye fittings.
- c) Sewers shall be provided with manholes at intervals not to exceed 400 feet. See Section XVII for manhole location requirements.
- d) Sewer main and lateral sewers shall have a minimum diameter of 8 inches, and shall have a minimum slope of 0.4%. 10-inch diameter sewers shall have a minimum slope of 0.28%.
- e) Sewer main and lateral sewers that have less than 2 foot of cover or are not placed on virgin soil shall be constructed of ductile iron pipe.
- f) Sewer main and lateral sewers that have between 2 foot and 4 foot of cover shall be constructed of DR18 or ductile iron pipe.
- g) Sewer main and lateral sewers that have over 4 foot of cover may utilize SDR35 pipe.

#### 5. Installation / Backfilling Requirements

- a) The width of trenches shall be adequate to allow sewer pipe to be laid and joined properly and to allow bedding and haunching to be placed and compacted to adequately support the pipe.
- b) The embedment material around the PVC pipe shall be installed in layers not exceeding six inches. The embedment material shall be Class I, Class II, or Class III. Class I material shall conform to the following standards: minimum particle size 3/4 inches, not less than 50% weight of material shall pass the 3/8-inch sieve. Class II material is defined as coarse sands and gravels with maximum particle size of 40 mm (1-1/2 inches), including variously graded sands and gravels containing small percentages of fines, generally granular and non-cohesive, either wet or dry. Unified Soil Classification types GW, CP, SW, SP are included in this Class. Class III material is defined as fine sand and clayey gravels, including fine sands, sand clay mixtures, and gravel - clay mixtures. All backfill material within one foot horizontally and one foot above the crown of the pipe shall be placed by hand and requires hand compaction.
- c) Each layer of Class II and Class III material shall be compacted to a minimum density of ninety-five (95) percent of maximum density of the soil as determined by the Standard Proctor Test AASHTO designation T-99.
- d) For additional requirements concerning the installation of PVC sewer pipe, refer to ASTM standard D-2321 "Underground Installation of Thermoplastic Pipe for Sewers and Other Gravity- Flow Applications".



## 6. Testing

Deflection testing of every section of sewer main or lateral sewers, constructed of PVC, is required by the Department. The total vertical wall deflection of the PVC pipe, as determined by testing not earlier than 30 days after placement and compaction of the final backfill, shall not exceed four (4) percent of the inside pipe diameter. The deflection shall be checked by manually pulling a "GO - NO GO" deflection testing mandrel through the pipe. The contractor shall conduct the tests under the observation of the certifying engineer / architect.

## 7. Certification

For projects that involve a sewage collection system, a licensed engineer / architect shall certify that all material, method of construction, installation, and testing of the sewer pipe meet the requirements of these standards as well as plans approved by the Department. Refer to **Appendix C** of these standards.

# XX. SEPARATION OF SEWER AND WATER LINES

## 1. Parallel Installation

- a) Sewers shall be laid at least 10 feet horizontally from any existing or proposed water main or lateral. The distance shall be measured edge to edge.
- b) If it is not practical to maintain a horizontal separation of ten feet, the department may allow a deviation on a case-by-case basis. Such deviation may allow for the installation of the sewer to be a minimum of 5 feet to a water main or lateral, if the bottom of water main or lateral is at least 18 inches above the top of the sewer line.
- c) If the vertical separation as described in item 2 above cannot be obtained, the department may allow a deviation on a case-by-case basis. Such deviation may allow for the installation of the sewer to be a minimum of 5 feet to a water main or lateral, if the bottom of the water main or lateral is at least 12 inches above the top of the sewer line and both are constructed of pressure rated pipe.

## 2. Crossings

- a) The crossing of water and sewer lines should be avoided unless proven absolutely necessary.
- b) Water Line over Sewer Line

In the event that the water line must cross over the sewer line, the following conditions shall be met:

- i. sewer lines shall be laid below the water line and provide a separation of at least 18 inches between the bottom of the water line and the top of the sewer line; and
- ii. sewer line joints shall be at least 10 feet from the point of crossing; and

- iii. when it is not practical to obtain an 18-inch separation, both the water and sewer lines shall be constructed of pressure pipe and have a minimum separation of 12 inches between the bottom of the water line and the top of the sewer line.

c) Sewer Line over Water Line

In the event that the sewer line must cross over the water line, the following conditions shall be met:

- i. adequate structural support shall be provided for the sewer to maintain line and grade; and
- ii. water line and sewer line joints shall be at least ten feet from the point of crossing; and
- iii. the entire length of sewer line between adjacent manholes or other sanitary structures shall be constructed of materials and joints that are equivalent to water main standards of construction; and
- iv. a vertical separation of at least 18 inches shall be provided between the bottom of the sewer line and the top of the water line. In the event that this distance cannot be maintained, the department may allow a deviation on a case-by-case basis. In no case shall the separation distance be less than 12 inches between the bottom of the sewer line and the top of the water line.

## **XXI. SEPARATION OF SEWER AND DRAINAGE LINES**

1. Sewers shall be laid at least 5 feet horizontally from any existing or proposed drainage line. The distance shall be measured edge to edge.
2. In the event that the drainage line must cross over the sewer line, the sewer line must be constructed of ductile iron pipe unless a separation distance of 18 or more inches is maintained.
3. In the event that the sewer line must cross over the drainage line, the sewer line shall be constructed of ductile iron pipe for a distance of 3 feet horizontally into virgin soil.
4. If perimeter roof drainage piping is installed near the face of the building, all house connections must be constructed of ductile iron pipe for 10 feet from the building.

## **XXII. BACKFILL AND FINAL GRADING**

1. Backfill and Final Grading

The completed system shall be backfilled and covered with suitable soil following permission to do so by the Department. The property shall be graded to minimize surface drainage into the system. A maximum 5 percent slope downward shall be maintained for 20 feet horizontally from the nearest edge of the leaching portion of the structure(s) to the toe of the slope before

tapering off to prevent seepage of the leachate through the slope. Dummy rings that are utilized to bring the system to grade shall be permitted to be placed at a lesser horizontal distance. Steep grades further than twenty feet from the leaching structures shall be stabilized pursuant to local codes.

## 2. Retaining Walls

- a) In cases where grading and slopes do not meet the requirements of paragraph 1. of this section, the utilization of retaining walls shall be required. In such cases, the retaining walls shall be designed by a licensed design professional in accordance with good engineering practice and applicable building codes. All retaining walls shall be shown as part of a grading and plot plan. Retaining walls designed to retain sewage are considered part of the sanitary system.
- b) Retaining walls shall be constructed to meet the following requirements:
  - i. Retaining walls that are located within 20 feet of the sewage disposal system shall be constructed of reinforced concrete.
  - ii. No part of the sewage disposal system shall be placed closer than 10-feet from a retaining wall.
  - iii. If the leaching structures are located closer than 20 feet from the retaining wall, waterproofing will be required to prevent the seepage of leachate through the wall.

## XXIII. SEWAGE PUMP STATIONS

### 1. General Requirements

Sewage disposal systems should be designed to flow by gravity. Only when absolutely necessary should pump stations be used. In such cases, the sewage pump station plans shall be prepared by a licensed design professional and must be reviewed and approved by the Department. In addition, construction and installation of sewage pump stations must be certified by a licensed professional engineer. For additional information concerning sewage pump stations refer to **GLUMRB - Recommended Standards for Wastewater Facilities -2014 edition (or latest revision)** and **NYSDEC - Design Standards for Intermediate Sized Wastewater Treatment Systems – March 5, 2014 edition (or latest revision)**.

### 2. Location

- a) Sewage pump stations and valve chambers must be located in an area that is easily accessible for proper operation and routine maintenance. Security fencing shall be provided around pump station installations. Refer to Section XI for additional requirements concerning the location of sewage pump stations.

- b) Whenever practical, pumping stations that are utilized as lift stations within an on-site sewage disposal systems shall be located after the septic tank or I/A OWTS. In no instance shall the pump station be located prior to the grease trap.
- c) Whenever practical, pump stations shall not be located in groundwater.

### 3. Design / Construction Requirements

- a) All sewage pump station components are to be constructed of precast reinforced concrete or non-precast material such as fiberglass or plastic (except metal) and designed to be traffic bearing that meets the requirements of AASHTO H-20 unless proper protection is installed to prevent vehicular traffic from driving over the pump station. Concrete pumping stations shall have a minimum inside diameter of four (4) feet. Pump stations may be constructed of other materials if they are watertight, non-corrodible, and structurally sound.
- b) The bottom and side portion, up to 18 inches above the inlet invert, of the station shall be monolithically constructed. In cases where this is not practicable, the pumping station shall be waterproofed up to 18 inches above the invert and leaked tested to ensure tightness prior to operation. Maximum permissible leak rate is ¼ inch in 8 hours.
- c) Inlet sewer pipes penetrating the sidewall of the pump station shall be provided with cast-in-place rubber sleeves with stainless steel tightening devices or with a flexible rubber sleeve that conforms to ASTM C-923.
- d) Pump station wet well volume shall be sized to prevent excessive retention of sewage while preventing frequent cycling of pumps. Minimum cycle times between 15 and 30 minutes are recommended. This requirement does not apply to pump stations installed after a septic tank or I/A OWTS.
- e) The floor of the wet well shall be sloped toward the pump units to prevent the deposition of sewage solids.
- f) Precast concrete sections shall be sealed with one (1) - inch butyl rubber joint sealant, which conforms to ASTM C-990.
- g) The maximum permissible depth of a pump station from grade shall be 30 feet.

### 4. Mechanical Requirements

- a) Duplex submersible sewage pumps that are automatically alternated shall be provided. A hand-off-automatic (HOA) switch shall also be provided for each pump. Each pump shall be capable of meeting the anticipated peak sewage design hydraulic flow rate.
- b) In some cases, where the pump station is receiving raw sewage, grinder type sewage pumps may be required.

- c) Pumps shall be readily removable and replaceable without dewatering the wet well or disconnecting any piping in the wet well. Stainless steel guide rails together with slide away flanges, or quick disconnect couplings shall be provided for this purpose.
- d) Pump discharge piping within the pumps station shall be constructed of ductile iron or stainless steel piping.
- e) Pump stations shall have adequate ventilation, by providing an intake fan that forces fresh air into the bottom of the lift station. The intake fan shall be capable of providing 12 air changes per hour for continuous operation or 30 air changes per hour for intermittent operation. An exhaust vent shall also be provided to remove sewer gases. Odor control equipment may be required for the exhaust vent.
- f) A hinged and lockable (non-skid) aluminum or stainless steel door shall be provided to allow accessibility to the pumps.
- g) A non-corrodible ladder with safety climb device shall be provided for access to the pumping station.
- h) A hinged and lockable (non-skid) aluminum or stainless steel door shall be provided to allow access to the ladder.
- i) Each pump shall be equipped with a stainless steel chain or cable. In addition, a pump-lifting device shall be provided on-site to facilitate the removal of the pumps.
- j) There shall be no physical interconnection between any potable water supply and a sewage pumping station or any of its components.

## 5. Electrical Requirements

- a) All electrical components, including pumps, fans, and wiring, shall be explosion proof and conform to the requirements for Class I, Division 1, Group D of the National Electrical Code.
- b) There shall be no electrical splices, junction boxes, or connections of any kind in the sewage wet well. Junction boxes shall be located within a NEMA 4X enclosure outside of the pump station wet well.
- c) The pump station shall be provided with a minimum of five pump control switches. These include: a) “Low Level Alarm”, b) “Pumps Off”, c) “Lead Pump On”, d) “Lag Pump On”, and e) “High Water Alarm”. Encapsulated mercury filled float switches shall be used for this purpose. A hand-off-automatic (HOA) switch shall also be provided.
- d) Pump stations shall be provided with a dialer alarm that is activated by the low level and high-level alarms.

- e) Alternative pump control devices, such as, a multitrode or bubbler system may be accepted in lieu of float controls. If an alternative device is utilized, a redundant high-level float and low-level float must be provided. The high-level alarm shall activate the dialer alarm and operate the pumps throughout the throw of the float. The low-level alarm shall activate the dialer alarm.
- f) Pump station control panels should be located within a building or other enclosure when possible. If required, control panels may be located outside of buildings, if the controls are located within a NEMA 4X rated enclosure that is placed within another NEMA 3R box.
- g) If pump control panel(s) are not within line of sight of the pumping station, then the pumps shall be outfitted with local disconnect switches at the pump station in lieu of a junction box.
- h) When pump stations are serving Multiple Residential Type projects, a permanent emergency power generator set with an automatic transfer switch shall be provided at the site. For other types of projects, consult the Department. All equipment and installation shall conform to the requirements of the National Electrical Code.
- i) A permanent light fixture shall be provided in the pump station wet well.

## 6. Valve Chamber

- a) The valve chamber shall be constructed of precast reinforced concrete and designed to be traffic bearing that meets the requirements of AASHTO H-20.
- b) Each pump shall be provided with a check and shut-off or isolation valve located within a separate chamber, outside of the pump station.
- c) The piping within the valve vault shall be constructed of ductile iron or stainless steel piping.
- d) A hinged and lockable aluminum or stainless-steel door with a non-skid surface shall be provided over the valve chamber to allow accessibility to all valves.
- e) If necessary, access steps, constructed of polypropylene coated 2-inch steel bar shall be provided to access all valves from finished grade.
- f) A permanent light fixture shall be provided in the valve chamber.

## 7. Certification

For projects that involve a sewage pumping station, a licensed design professional shall certify that all materials, method of construction, installation, and testing of the sewer pipe and equipment meet the requirements of these standards as well as plans approved by the Department. Refer to **Appendix C** of these standards.

## 8. Exceptions

The Department may accept pump station designs, which vary from the standards in cases of small sewage flows if the licensed design professional submits engineering justification acceptable to the Department. Examples of such variations include low-pressure pump stations, septic tank effluent pumping systems (STEP system), or pump stations/lift stations installed after a septic tank or I/A OWTS.

## XXIV. SEWAGE FORCE MAINS

### 1. Materials

Force mains may be constructed of either, HDPE, PVC and/or ductile iron in accordance with the following criteria:

- a) Plastic (PVC) sewer pipe used for force mains that have a diameter less than 4 inches shall be constructed of schedule 40 or 80 PVC pipe and meet the requirements of ASTM standard D-1785. Fittings shall have bell push-on joints and rubber-sealing rings constructed of ductile iron, grade 65-45-12, in accordance with ASTM standard A-536. The rubber sealing rings shall meet the requirements of ASTM standard F-477.
- b) Plastic (PVC) sewer pipe and fittings used for force mains that have a diameter of four (4) inches or greater shall have a minimum rating of SDR-18 and meet or exceed the requirements of the AWWA C-900 series standards. Rubber sealing rings shall meet ASTM F-477.
- c) HDPE sewer pipe used for force mains that have a diameter of four (4) inches or greater shall have a minimum rating of SDR-9 and meet or exceed the requirements of the AWWA C-900 series standards.
- d) Ductile iron pipe shall conform to AWWA C-150 and C-151 standards and have a minimum class 52 designation. Ductile iron push-on-joints used with this pipe shall conform to AWWA C-111; fittings shall meet AWWA C-110 and C-153 standards.

### 2. Design

- a) Force mains shall be designed to provide a minimum flow velocity of 2 feet per second and a maximum velocity of 8 feet per second. No force main shall have an inside diameter of less than two (2) inches.
- b) Force mains used to pump raw sewage shall have a minimum diameter of 4 inches, unless grinder pumps are used.
- c) Thrust blocks or restraints shall be provided where applicable throughout the length of a force main and shall be designed to contain the resultant thrust forces. Thrust blocks and restraints shall conform to AWWA C-600 standards.

- d) Force mains shall be located a minimum of 4.5 feet below finished grade to protect against freezing. In certain cases, force mains may have less soil cover, provided the line is pitched so that sewage is not retained in the line between pump cycles.

### 3. Installation Requirements

- a) The width of trenches shall be adequate to allow sewer pipe to be laid and joined properly and to allow bedding and haunching to be placed and compacted to adequately support the pipe. Refer to Section XIX, paragraph E concerning the material used for embedment around PVC pressure pipe.
- b) For additional requirements concerning the installation of PVC pressure pipe, refer to ASTM standard D-2774 "Practice for Underground installation of Thermoplastic Pressure Piping".
- c) Force mains constructed of ductile iron pipe shall be installed in accordance with AWWA C-600 standard.
- d) Provide drain manholes at low points and air relief chambers/manholes at high points.
- e) Provide a cleanout assembly at 400' max. intervals and at bends equal to 45-degree and greater.
- f) Concrete thrust blocks shall be provided at all bends.

### 4. Testing

Force mains shall be pressure tested at 200 psi for a minimum of 30 minutes to ensure water tightness prior to backfilling. The contractor shall conduct the test in the presence of the certifying design professional.

### 5. Certification

A licensed design professional shall certify that all material, methods of construction, installation and testing meet the requirements of these standards as well as plans approved by the Department. Refer to **Appendix C** of these standards.

### 6. Exceptions

The Department may accept force main designs, which vary from the standards in cases of small sewage flows if the licensed design professional submits engineering justification acceptable to the Department. . Examples of such variations include low-pressure pump stations, septic tank effluent pumping systems (STEP system), or pump stations/lift stations installed after a septic tank or I/A OWTS.



**XXV. PUMP-OUT FACILITIES**

## 1. General

When required, pump-out facilities for the purpose of emptying marine vessel, bus, or RV holding tank wastes shall be located in areas that are easily accessible for proper operation, maintenance, or replacement. The construction of such facilities shall meet the requirements of the NYSDEC and all other applicable authorities where required. Provisions for pump-out facilities should be based upon the following guidelines:

## 2. Design Considerations

- a) Pump-out units may be portable or permanent, and should include a vacuum pump or a positive displacement type of pump to empty marine vessel and boat holding tank wastes. Pump-out units may be electrically or manually operated. If pump-out units are electrically operated, then all electrical components must be explosion proof, and meet NEC requirements.
- b) All pump-out units shall be provided with a flexible suction hose and dripless nozzle.
- c) All mechanical and electrical components must be adequately protected from freezing.
- d) Pump-discharge piping or force mains must be constructed of materials and joints that meet water main standards. The force main may be constructed of Type 1, Grade 1, schedule 80 PVC sewer pipe, or PVC pressure rated SDR 18 pipe.
- e) All pump-out units should be provided with a non-potable water service and an approved backflow prevention device for rinsing the onboard holding tanks.
- f) Holding tanks shall be located in accordance with **Table 2** Section XI.
- g) The minimum capacity of any holding tank shall be 1000 gallons, but a greater volume may be required, as determined by the Department.
- h) Holding tanks shall be made watertight and leak tested to ensure tightness prior to operation. Maximum permissible leak rate is  $\frac{1}{4}$  inch in 8 hours.
- i) Holding tanks shall not have an outlet pipe but shall be provided with a hinged and locking access port. A locking cast iron frame and cover shall be provided at finished grade over the access port. Both the access port and access cover shall be watertight and insect proof.
- j) Holding tanks shall be properly vented, and shall be equipped with a liquid level float switch, high water level alarm and auto dialer or other acceptable automatic notification system.
- k) All mechanical and electrical equipment shall meet the requirements of the NEC.

### 3. Disposal of Holding Tank Wastes

- a) Holding tank wastes must be pumped out on a routine basis by a licensed scavenger vehicle and discharged to an acceptable treatment facility.
- b) Discharge of holding tanks wastes to an on-site sewage disposal system is prohibited.

### 4. Certification Required

A design professional shall supervise the installation of pump-out facilities and certify that the systems are constructed in accordance with the approved plans and applicable codes.

### 5. Exceptions

- a) For cases where a municipal sewer is available, the marine vessel, bus, or RV waste can be pumped directly to the sewer system in lieu of providing an on-site holding tank.
- b) For cases where NYSDEC approval is required, the Department may consider alternative designs for pump-out facilities.

## **XXVI. ALTERNATIVE SEWAGE DISPOSAL SYSTEMS**

### 1. General

The sewage disposal systems addressed thus far in these Standards are considered typical systems and may be used on sites with adequate soil percolation and vertical/horizontal separation distances unless otherwise prohibited. For sites that are not suitable for such systems, the use of alternative systems may be permitted by the Department without need for a variance if the design meets the conditions listed in section XXVI.2 and is acceptable to the Department. The Department reserves the right to require a variance to utilize an alternative system in accordance with Article 2 and Article 6 of the Suffolk County Sanitary Code at any time in conformance with section XXIX.

### 2. Design Considerations

In addition to the typical plan requirements, applications for alternative designs shall include the following:

- a) The system shall be designed by a licensed professional engineer.
- b) It is clearly demonstrated that the proposed system is physically equivalent or better than the conventional systems or I/A OWTS, in respect to storage capacity, leaching area, land area utilization, grading, accessibility, maintainability, reparability, life expectancy, effluent quality and reliability.
- c) An engineering report shall be submitted that defines the disposal system and determines that the proposed design is most suitable for the building site and that the

proposed sanitary system will function properly without causing any health hazard and will minimize the impact on the surrounding environment.

- d) The design engineer shall supervise the installation of the system and certify that the system was constructed in accordance with the approved plans. An inspection log shall be maintained and a copy submitted to the Department if requested.

### 3. Examples of Alternative Systems

- a) *Clustered Leaching Systems* - a leaching system that consists of shallow pools that are clustered to minimize the space requirement. Maximum effective depth of leaching rings shall not exceed 3 feet and can be located a minimum of 2 feet above the highest recorded groundwater elevation. Refer to Figure #16.
- b) *Chamber Leaching System* - a leaching system that consists of plastic chambers in lieu of concrete leaching pools and can be located a minimum of 2 feet above the highest recorded groundwater elevation.
- c) *Diffusion Well Systems* - a leaching system that utilizes wicks and other appurtenances to minimize the effects of poor soils.

## **XXVII. ABANDONMENT OF EXISTING SEWAGE DISPOSAL SYSTEMS**

Existing disposal systems that are proposed to be abandoned as part of a project may require sampling and remediation prior to abandonment. Once the Department has issued approval for the closure, the existing sanitary system shall be abandoned in accordance with the following requirements:

1. *Abandonment In-Place* - existing systems shall be abandoned by removing all residual sewage wastes by a licensed waste hauler, removing the top of the structure(s), backfilling with suitable sand and gravel material, and properly compacting.
2. *Abandonment by Removal* - existing systems may also be abandoned by removing all residual sewage wastes by a licensed waste hauler, removing the entire structure(s), backfilling with suitable sand and gravel material, and properly compacting.
3. *Abandonment of Sewer Piping* - the associated sewer piping shall be cut and capped as a means of abandonment. The Department should be contacted for further abandonment requirements, if future construction is contemplated in the area of the abandoned septic system.
4. *Certification Required* - the abandonment of existing sewage disposal systems, either in-place, or by removal, must be certified by either a licensed design professional or licensed contractor as indicated by the Department on the Permit to Construct. For projects served by municipal sewer districts, the appropriate municipal agency with jurisdiction should also be contacted.

## XXVIII. COVENANTS AND RESTRICTIONS

Restrictive covenants may be required when submitting an application to the Department. Covenant restrictions are applied on lots located in deep recharge or water supply sensitive areas and serve as notice regarding storage restrictions for toxic or hazardous materials or changes in use or occupancy. Other covenants restricting sanitary waste flows may be required where the Department determines that change in use could result in violation of approval conditions or when approval is contingent upon the applicant performing a future action. For further information, refer to Articles 6, 7, 12, 18, and 19 of the Suffolk County Sanitary Code.

## XXIX. VARIANCES

1. The Commissioner of the Department of Health Services, on written application, may grant a variance, in accordance with Section 220 of Article 2 of the Suffolk County Sanitary Code, from a specific provision of these Standards in a particular case, subject to appropriate conditions, where such variance is in harmony with the general purpose and intent of the Standards, and when such application for a variance has been considered by the Department in accordance with the requirements of Section 220 of Article 2 and Article 6 of the Suffolk County Sanitary Code.
2. The Commissioner may impose more stringent requirements in a specific case when necessary to ensure an adequate and satisfactory sewage and waste disposal system or to protect a sensitive habitat.

## XXX. APPROVAL BY THE COMMISSIONER OF HEALTH SERVICES

In accordance with Section 221, Article 2, of the Suffolk County Sanitary Code, the foregoing are **Standards for Approval of Plans And Construction For Sewage Disposal Systems for Other Than Single-Family Residences** approved by the Suffolk County Commissioner of Health Services and include the required details for submission of plans and other information to the Suffolk County Department of Health Services to assure conformity to the approved Standards. These Standards are adopted July 21, 2020 and are effective immediately.

*Signature on File*

---

Gregson H. Pigott, MD, MPH  
Commissioner of Health Services  
Suffolk County

*(Adopted 6/15/82; Amended 3/5/84, 2/5/88, 7/15/08, 11/20/08, 12/1/09, 12/29/17, 7/21/20)*

# FIGURE 1 TYPICAL SOIL PERCOLATION TEST ARRANGEMENT

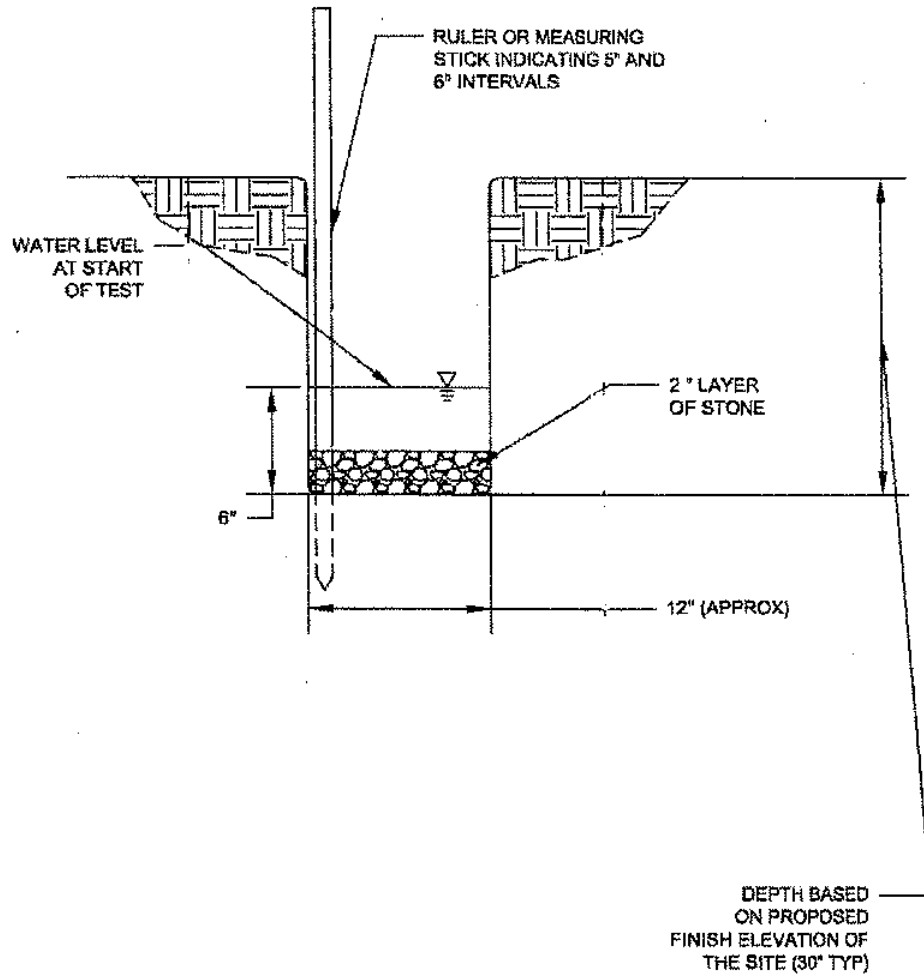

**FIGURE 2**  
**SINGLE UNIT CONCRETE SEPTIC TANK**

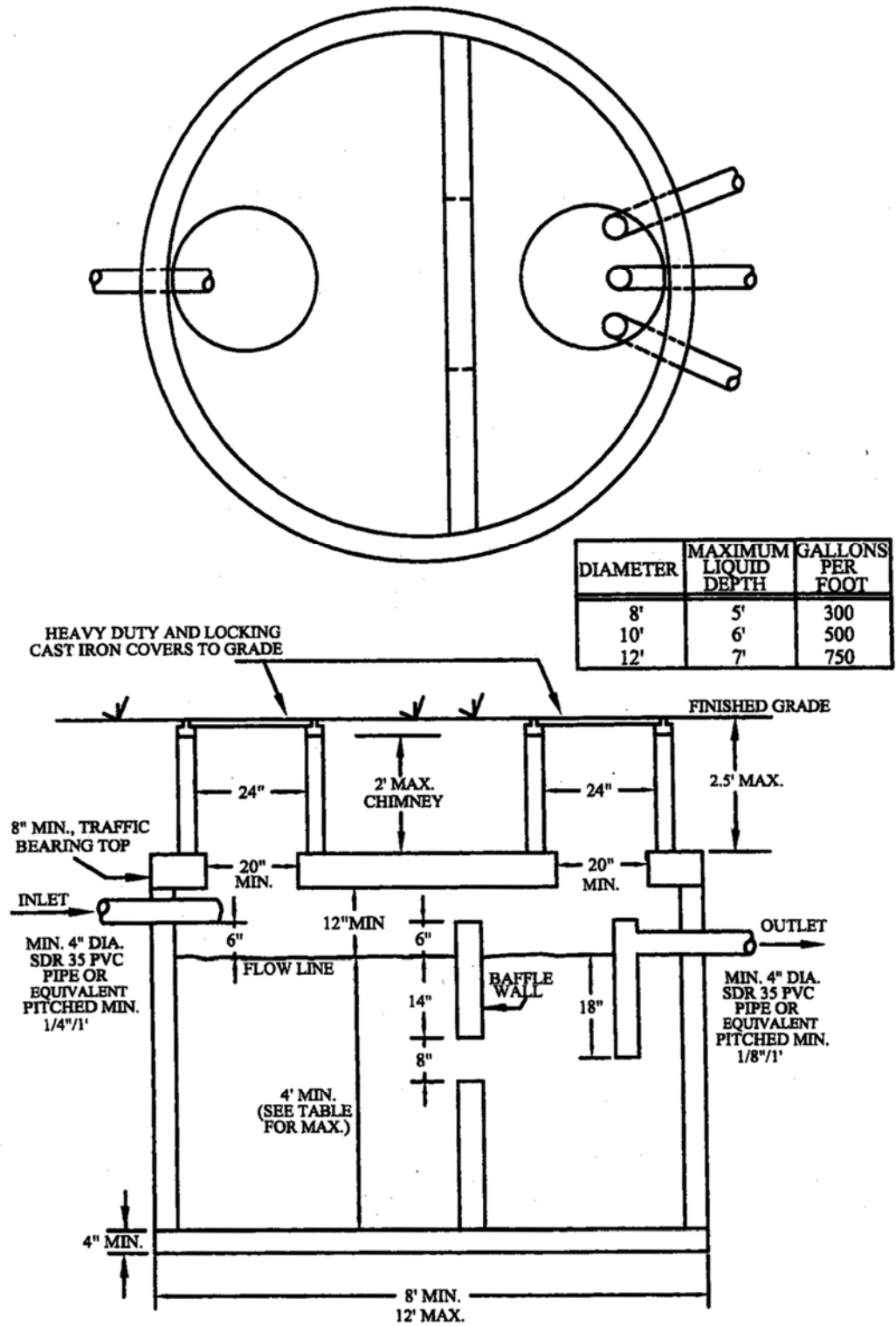

## FIGURE 3 TWO UNIT CONCRETE SEPTIC TANK

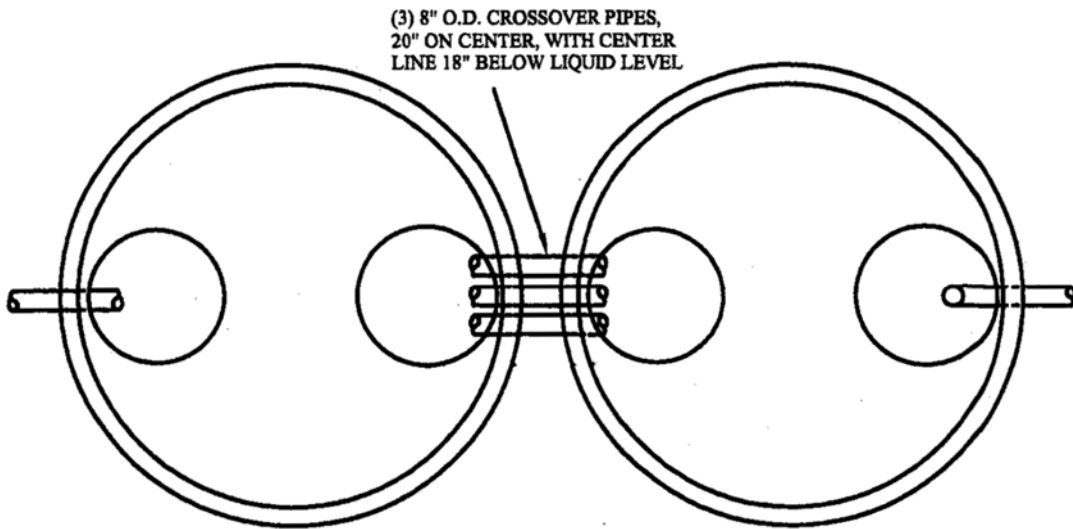

DIAMETER	MAXIMUM LIQUID DEPTH	GALLONS PER VERTICAL FOOT IN EACH TANK
8'	5'	300
10'	6'	500
12'	7'	750

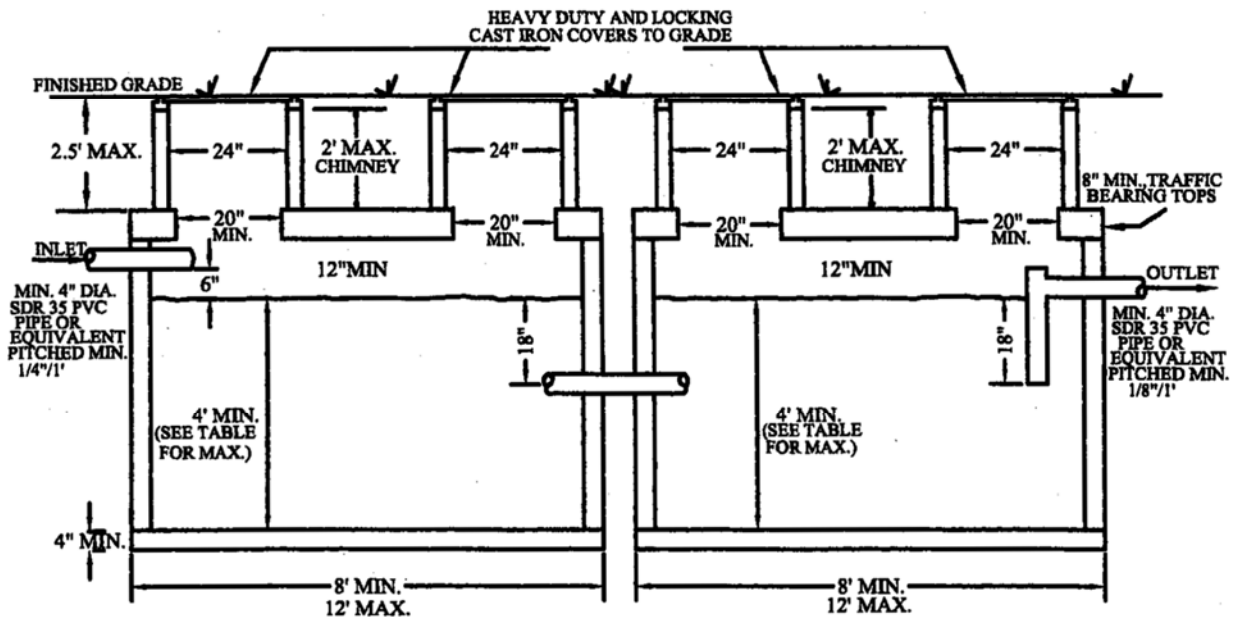

**FIGURE 4**  
**MULTIPLE UNIT CONCRETE SEPTIC TANK (3 & 4 UNITS)**

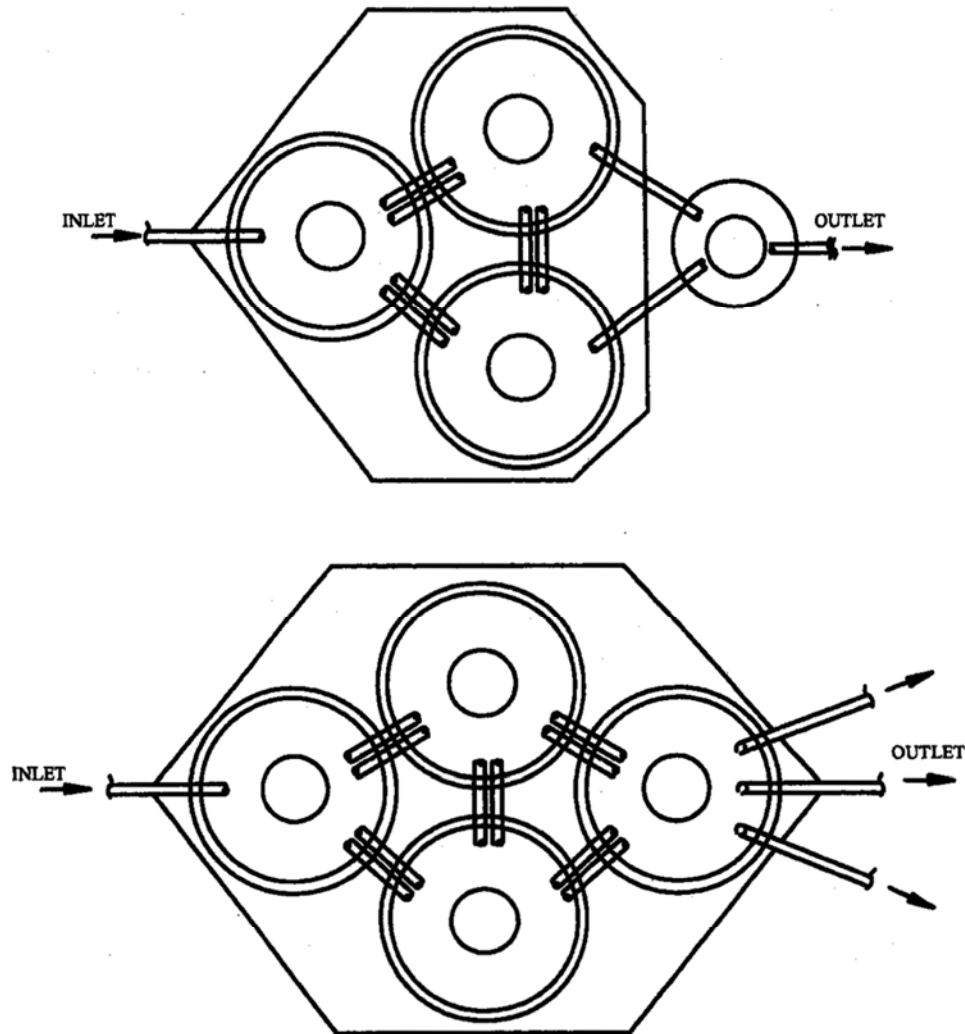

- (1) SEPTIC TANKS MUST BE CONSTRUCTED ON A COMMON REINFORCED CONCRETE SLAB AT LEAST 6" THICK.
- (2) EACH COMPARTMENT SHALL BE CONSTRUCTED OF REINFORCED PRECAST CONCRETE SOLID RINGS, SOLID DOMES OR TOP SLABS.
- (3) CROSSOVER PIPES MUST BE OF 8" O.D. PIPE, 20" ON CENTER, WITH CENTER LINE 18" BELOW LIQUID LEVEL.
- (4) COVERS MUST BE PLACED OVER INLET AND OUTLET FOR SLAB TOPS OR IN CENTER FOR DOME TOPS.



**FIGURE 5**  
**MULTIPLE UNIT CONCRETE SEPTIC TANK (5 & 6 Units)**

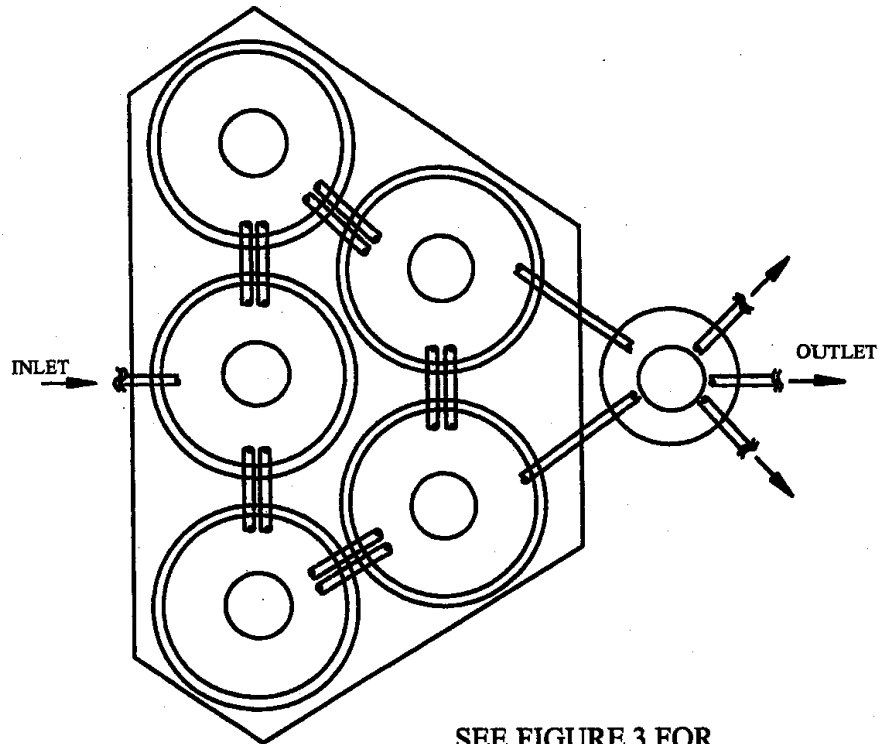

SEE FIGURE 3 FOR  
CONSTRUCTION NOTES

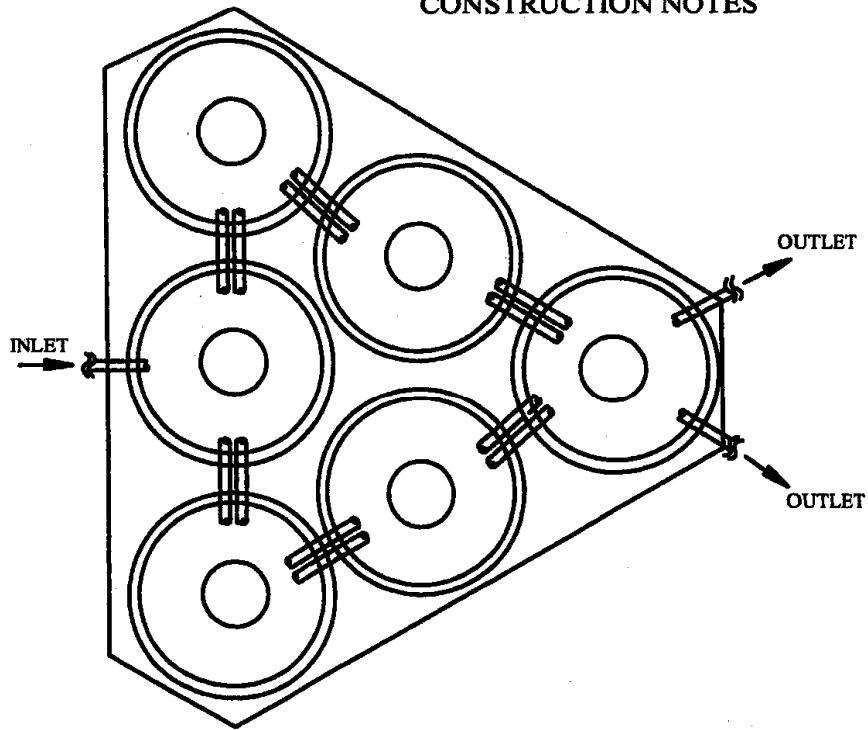

## FIGURE 6 SINGLE UNIT CONCRETE GREASE TRAP

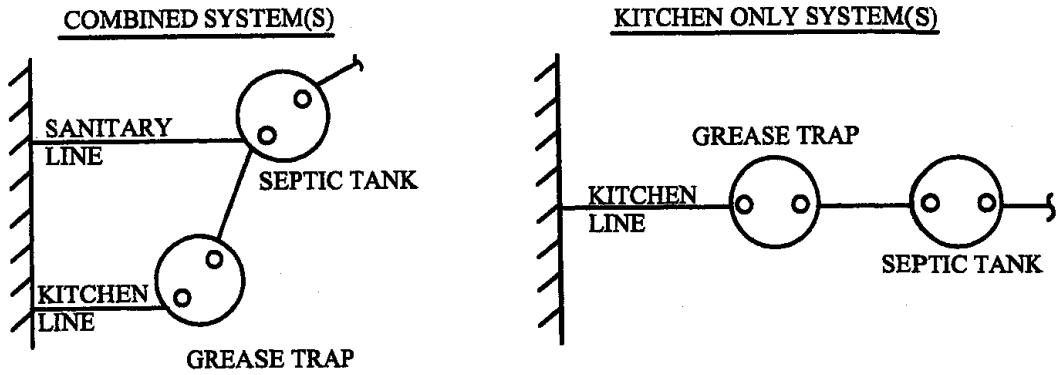

DIAMETER	MAX. DEPTH	GAL/FT
8'	5'	300
10'	6'	500
12'	7'	750

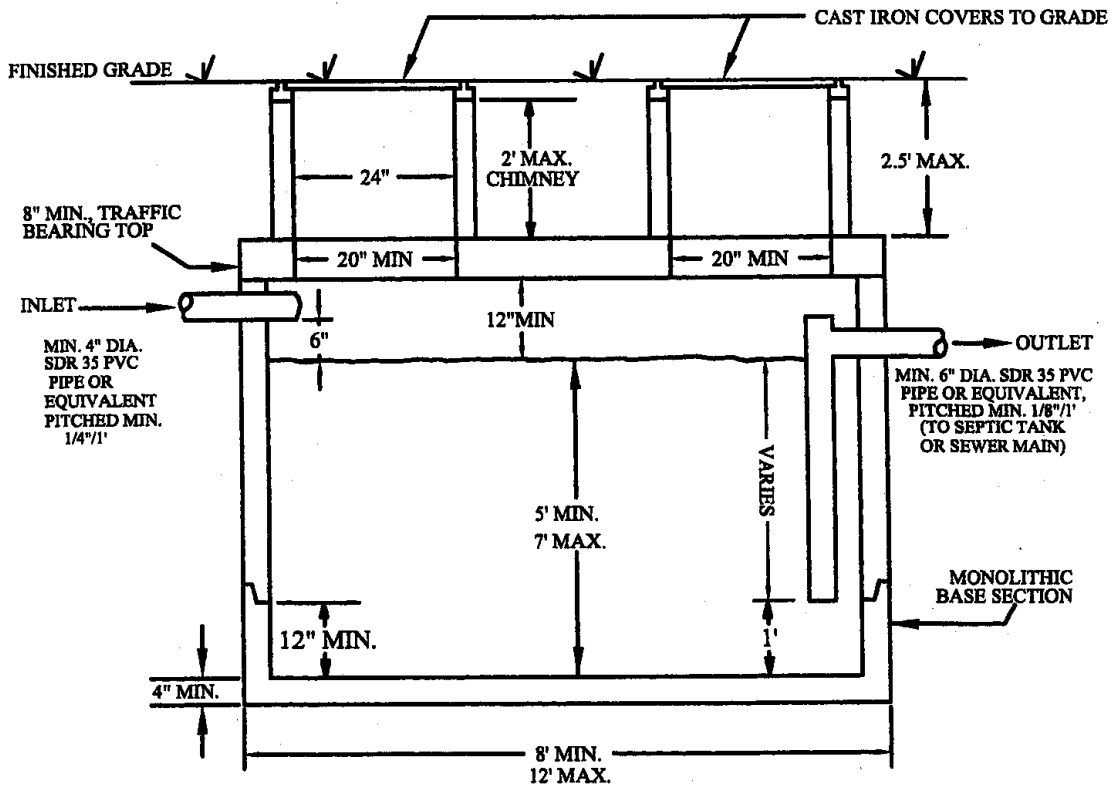

**FIGURE 7**  
**MULTIPLE UNIT CONCRETE GREASE TRAP**  
**(2 Tank Example)**

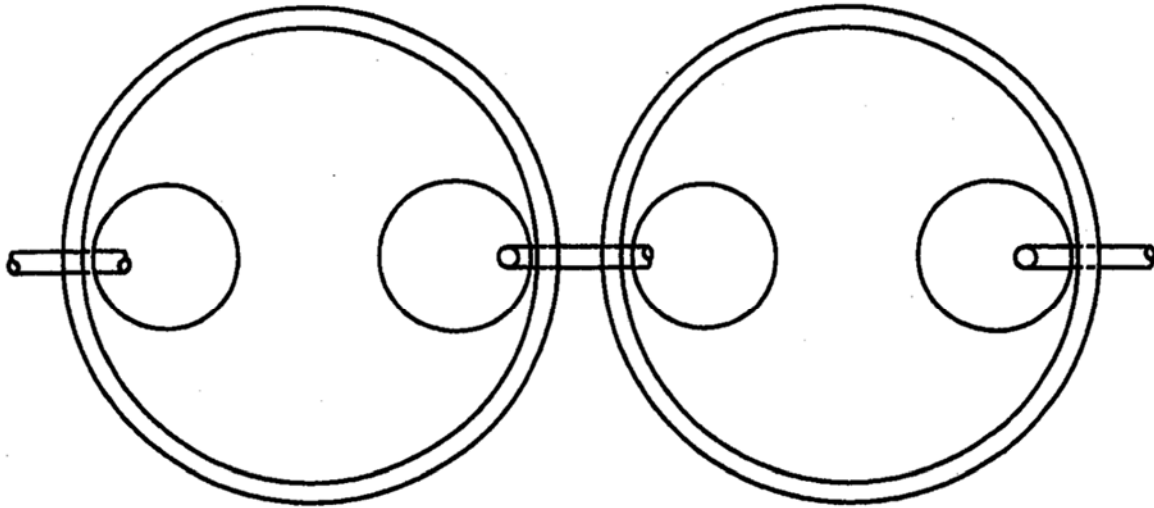

DIAMETER	MAXIMUM DEPTH	MINIMUM DEPTH		GAL/FT.
		INLET TANK	OUTLET TANK	
10'	6'	5.5'	5'	500
12'	7'	5.5'	5'	750

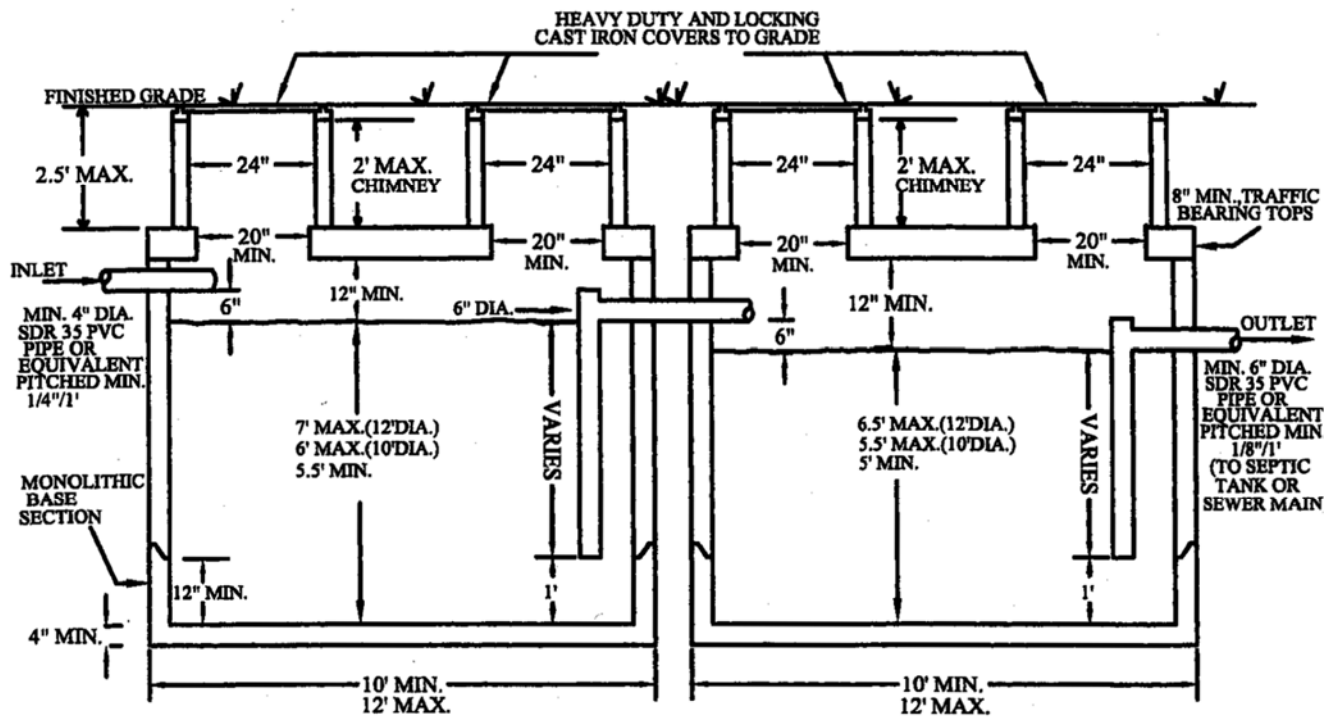

# FIGURE 8 CONCRETE LEACHING POOL DESIGN AND CONSTRUCTION DETAILS

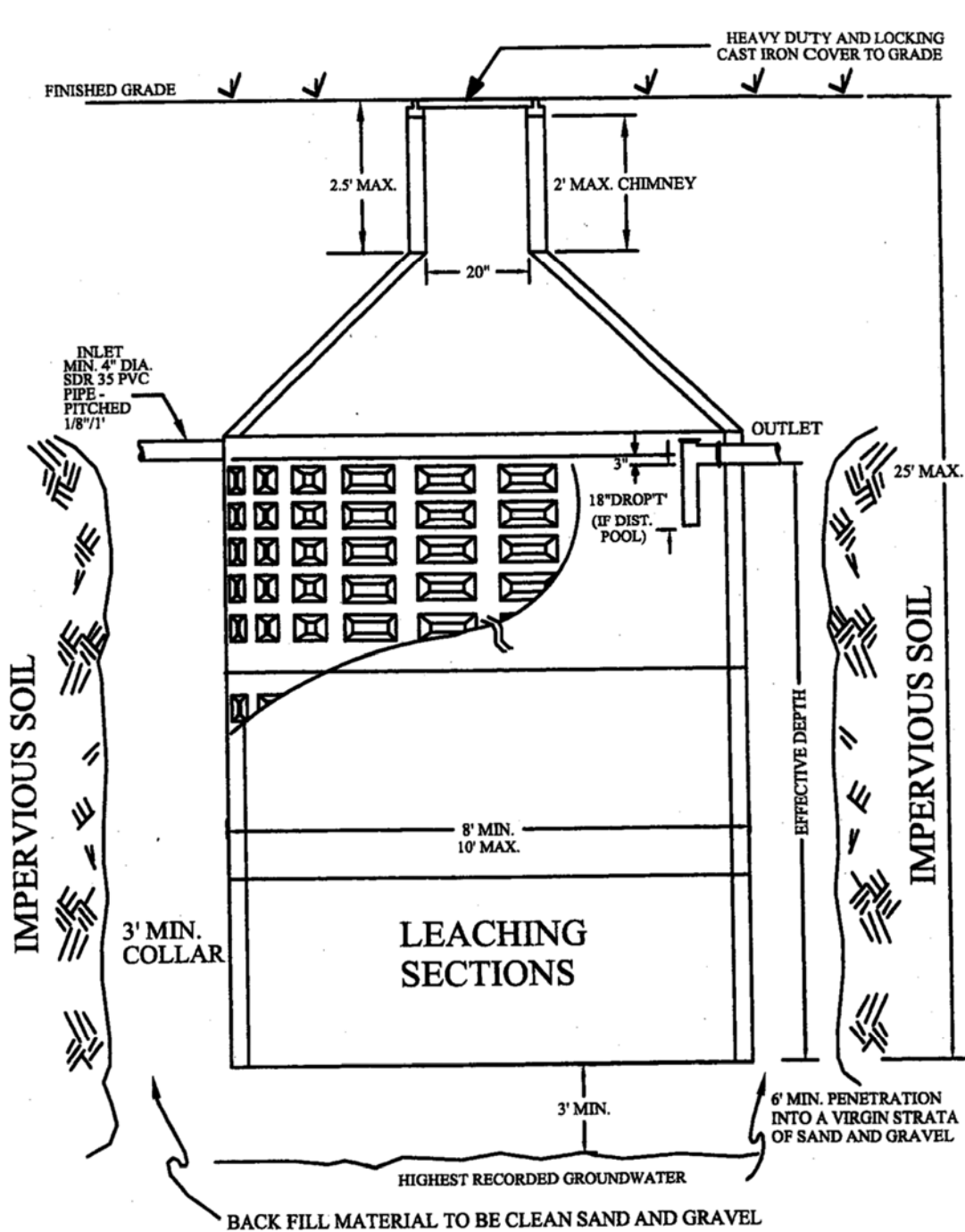

# FIGURE 9 CONCRETE LEACHING POOL ARRANGEMENT/LAYOUT

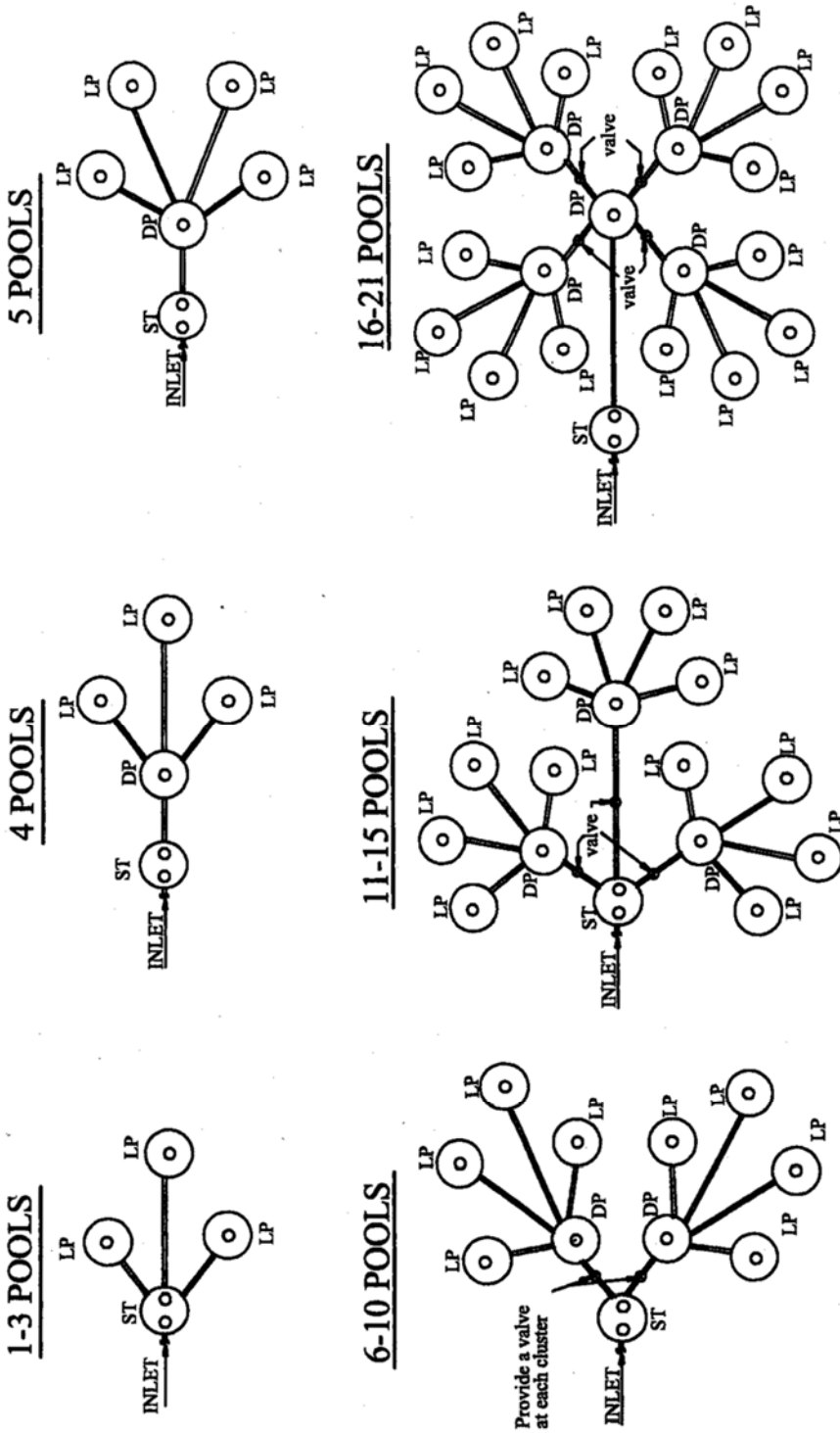

MAINTAIN EQUAL DISTRIBUTION OF POOLS IN EACH CLUSTER  
MAINTAIN 8' BETWEEN ALL STRUCTURES.

ST = SEPTIC TANK  
LP = LEACHING POOL  
DP = DISTRIBUTION POOL

## FIGURE 10 TYPICAL CONCRETE LEACHING GALLEY AND LAYOUT

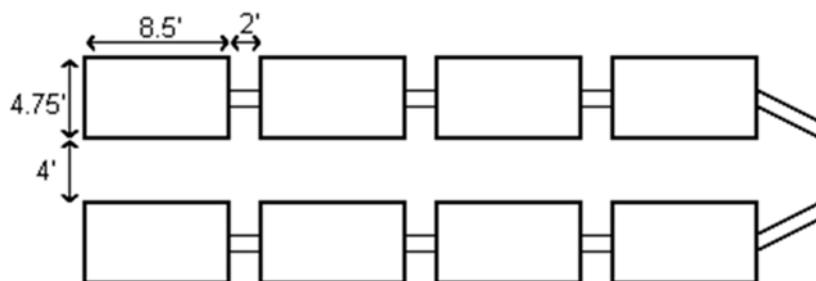
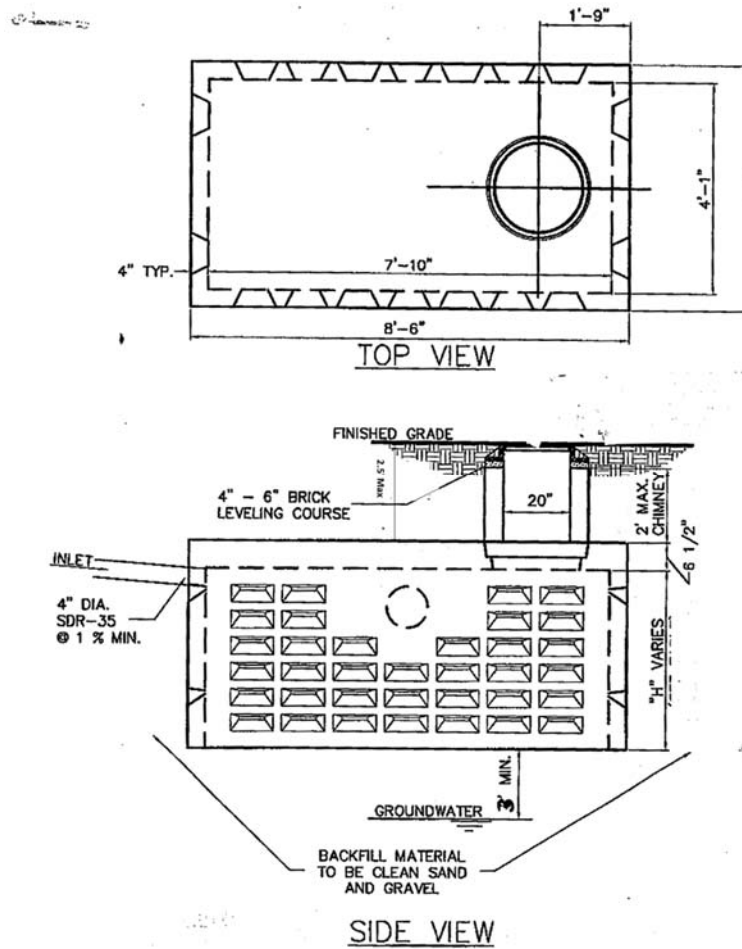

Dimensions (ft)			Area
Height	Width	Length	SF/Unit
2	4.75	8.5	53
2.5	4.75	8.5	66.25
3	4.75	8.5	79.5
3.5	4.75	8.5	92.75
4	4.75	8.5	106

## FIGURE 11 CONCRETE ACCESS/JUNCTION MANHOLE

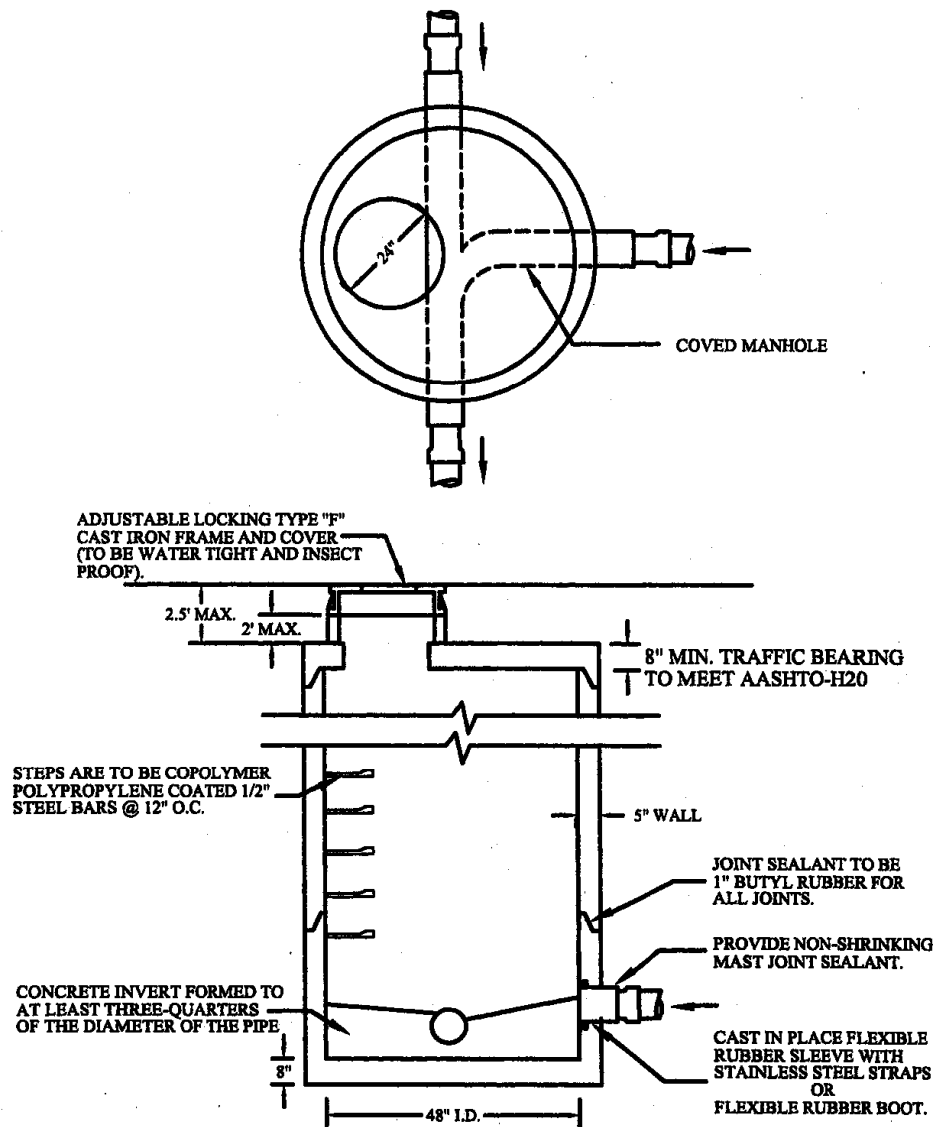

1. ALL MANHOLE SECTIONS SHALL CONFORM TO A.S.T.M. C-478, LATEST REVISION STANDARD SPECIFICATIONS FOR PRECAST REINFORCED CONCRETE M.H. SECTIONS.
2. MANHOLE RISER SECTION TO BE FURNISHED IN 1,2,3, OR 4' HEIGHTS, AS REQUIRED.
3. LOADING TO CONFORM TO AASHTO H-20 LOADING.
4. ALL CONCRETE IS TO MEET 4000 PSI AT 28 DAY SET.
5. OUTLET PIPE TO BE SET 0.1' MINIMUM BELOW INLET PIPES.
6. THE MAXIMUM CHANGE IN ELEVATION BETWEEN INLET AND OUTLET INVERT(S) SHALL BE NO GREATER THAN 2 FEET.

## FIGURE 12 CONCRETE DROP MANHOLE

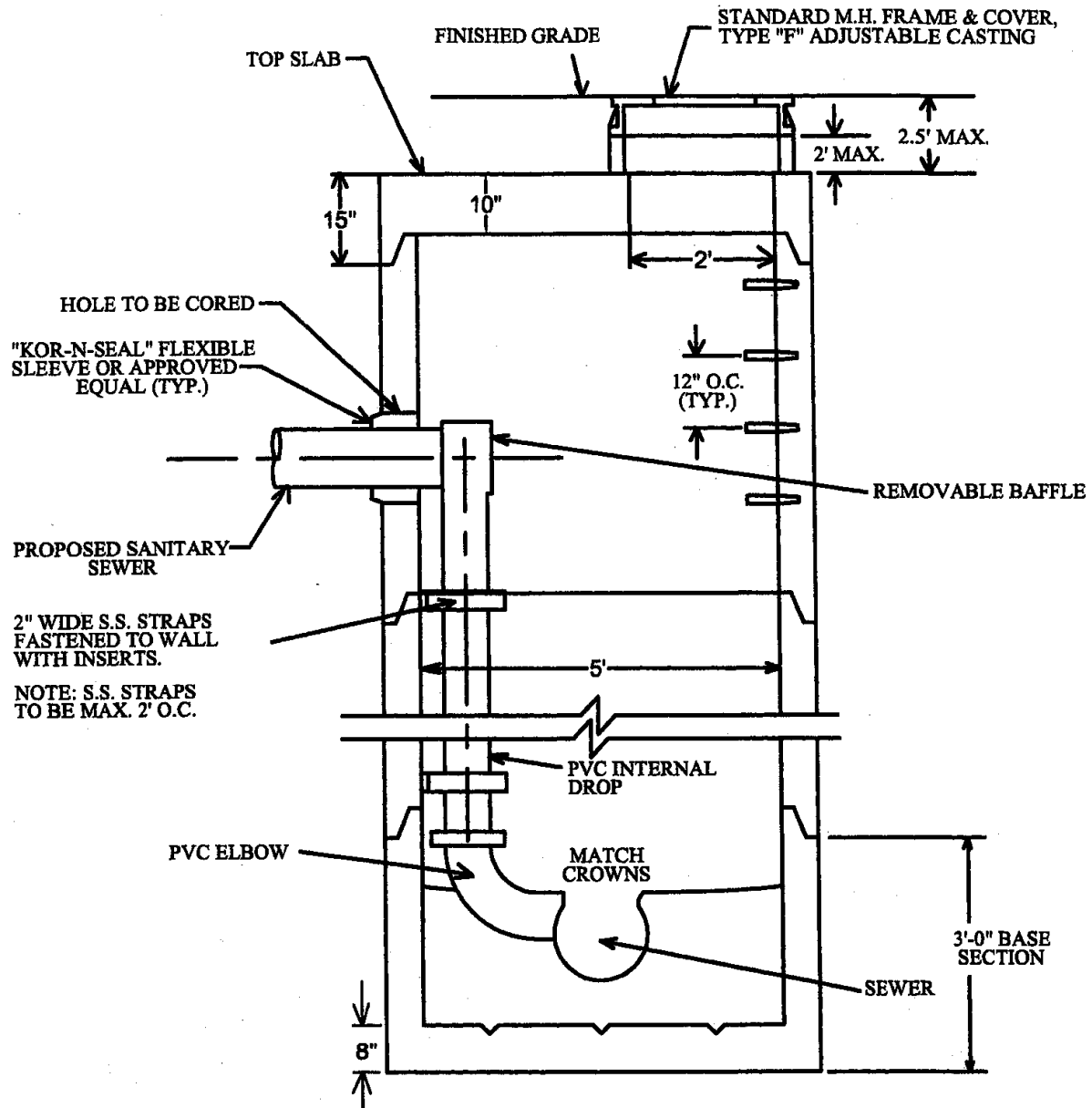

1. AN INTERNAL DROP ASSEMBLY SHALL BE USED AT ALL LOCATIONS WHERE THE INVERT ELEVATIONS DIFFER BY MORE THAN 2 FEET.
2. A 5' DIAMETER MANHOLE SHALL BE USED WHERE INTERNAL DROP MANHOLES ARE REQUIRED.



## FIGURE 13 CONCRETE DISTRIBUTION MANHOLE

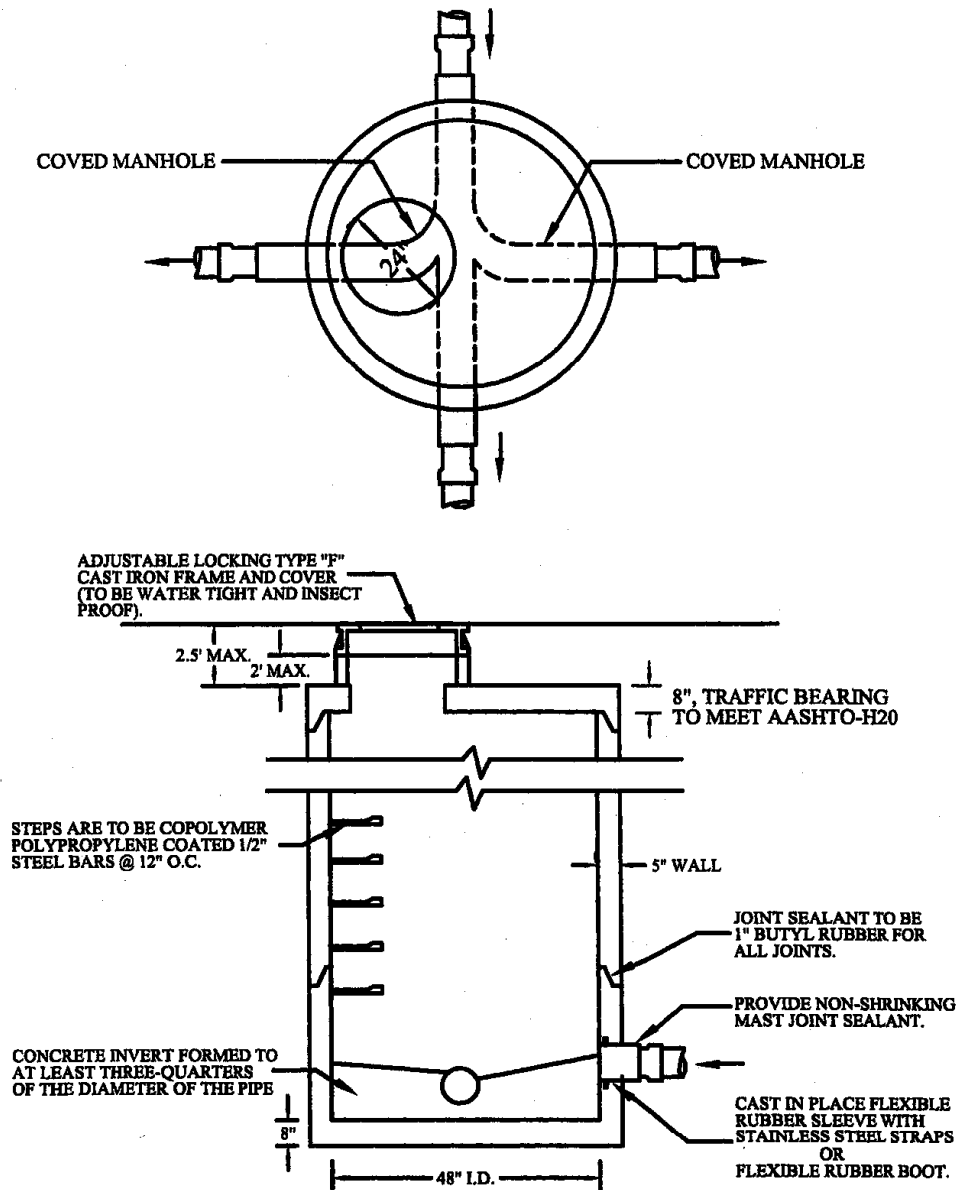

1. ALL MANHOLES SECTIONS SHALL CONFORM TO A.S.T.M. C-478, LATEST REVISION STANDARD SPECIFICATIONS FOR PRECAST REINFORCED CONCRETE M.H. SECTIONS.
2. MANHOLE RISER SECTION TO BE FURNISHED IN 1,2,3, OR 4' HEIGHTS, AS REQUIRED.
3. LOADING TO CONFORM TO AASHTO H-20 LOADING.
4. ALL CONCRETE IS TO MEET 4000 PSI AT 28 DAY SET.
5. ALL OUTLETS ARE TO BE SET AT THE SAME ELEVATION, 0.1' MINIMUM BELOW INLET(S).

## FIGURE 14 CONCRETE SAMPLING MANHOLE

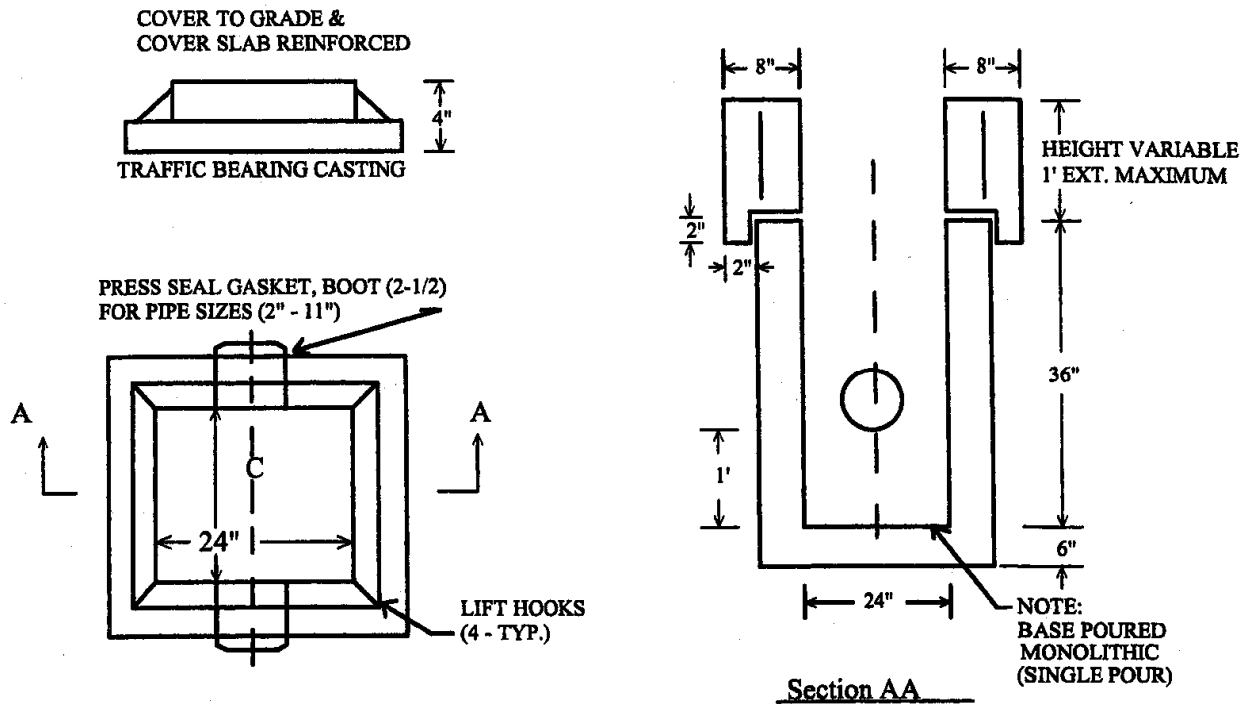

1. 2'X2' SEWER ACCESS PORT TO 4' MAXIMUM WORKING DEPTH
2. WORKING DEPTH = TOP OF MANHOLE COVER TO LOWEST PIPE INVERT

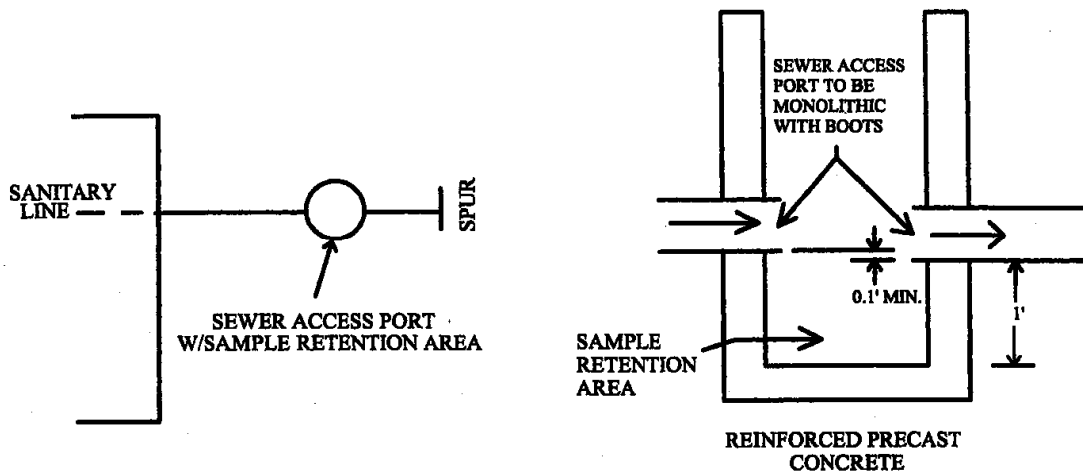

## **FIGURE 15** **TYPICAL CLEAN-OUT DETAIL**

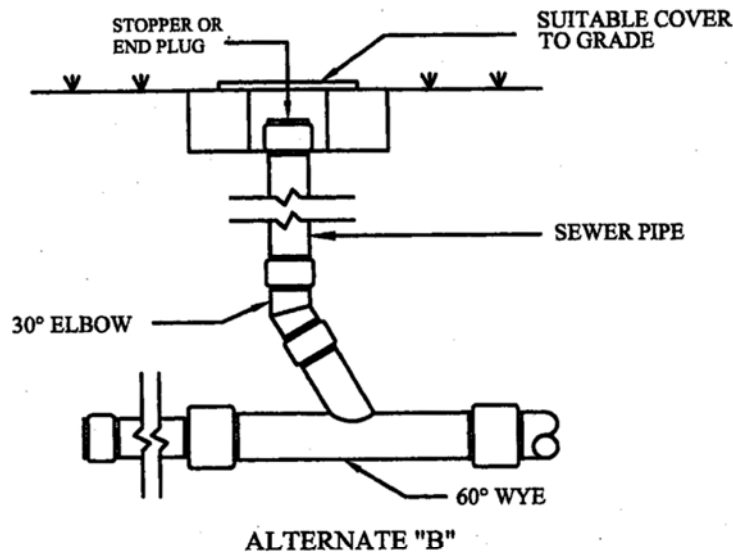
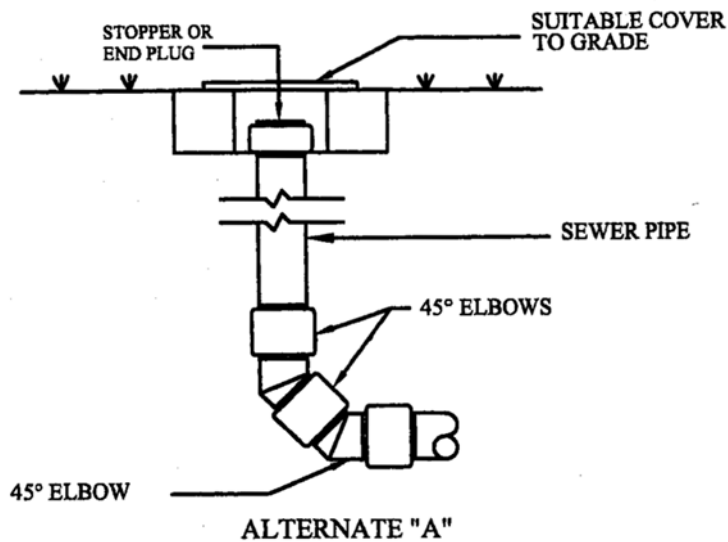

1. CLEANOUT(S) LOCATED IN TRAFFIC AREAS SHALL BE PROVIDED WITH TRAFFIC BEARING FRAME AND COVER.
2. IN ALL VIEWS, ALTERNATE "A" IS FOR BENDS, ALTERNATE "B" IS FOR USE WITH BUILDING EXTENSION/CONNECTION.

## FIGURE 16 PRE-CAST CLUSTERED DISPOSAL SYSTEM FOR HIGH GROUNDWATER

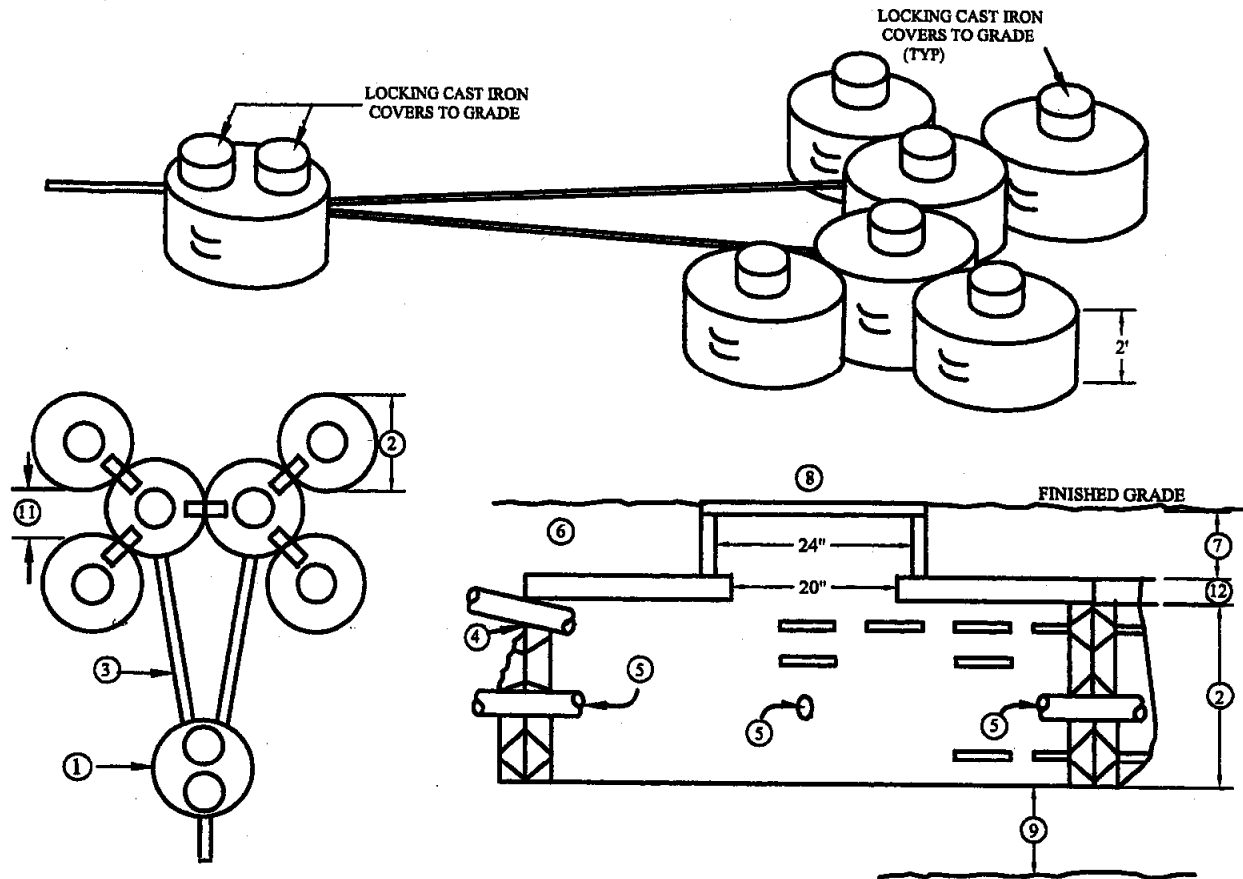

### DETAILS OF CONSTRUCTION

1. REINFORCED PRECAST CONCRETE SEPTIC TANK (1,200 GALLON MINIMUM).
2. USE SIX (6) 10 FT. DIAMETER, 2 FT. HIGH PRECAST CONCRETE LEACHING RINGS.
3. USE 4 INCH DIAMETER, APPROVED SEWER PIPE THROUGHOUT.
4. THE WASTE LINES FROM THE SEPTIC TANK SHOULD ENTER THE MIDDLE RINGS AS HIGH AS POSSIBLE.
5. USE A CROSS-OVER PIPE BETWEEN THE MIDDLE RINGS AND THE FOUR OUTSIDE RINGS, EIGHT (8) INCHES ABOVE THE BOTTOM.
6. BACKFILL MATERIAL SHALL BE COARSE SAND AND GRAVEL.
7. SLABS SHALL BE 2.5' MAXIMUM BELOW GRADE WITH A 2' MAXIMUM COLLAR.
8. SOLID HEAVY DUTY AND LOCKING CAST IRON COVERS TO GRADE ON ALL POOLS.
9. BOTTOM OF POOL SHALL BE A MINIMUM OF 2 FEET ABOVE HIGH RECORDED GROUNDWATER.
10. SHOW AREA FOR 50% EXPANSION OF THE LEACHING POOLS WHICH MAXIMIZES SIDEWALL AREA.
11. MAXIMIZE THE DISTANCE BETWEEN THE FOUR (OUTER) SATELLITE POOLS.
12. TOP SLAB SHALL BE 8" MINIMUM (THICKNESS) AND TRAFFIC BEARING.
13. EACH (6) POOL CLUSTER AS SHOWN, PROVIDES THE EQUIVALENT OF 300 SF OF SIDEWALL LEACHING AREA (DUE TO SIDEWALL MASKING). ADDITIONAL LEACHING CLUSTERS MAY BE ADDED AS NEEDED.
14. THIS DISPOSAL SYSTEM IS FOR AREAS WITH HIGH GROUNDWATER CONDITIONS.

COUNTY OF SUFFOLK



STEVEN BELLONE  
SUFFOLK COUNTY EXECUTIVE

SUFFOLK COUNTY  
DEPARTMENT OF HEALTH SERVICES  
DIVISION OF ENVIRONMENTAL QUALITY  
STANDARDS FOR APPROVAL OF PLANS  
AND CONSTRUCTION FOR  
SEWAGE DISPOSAL SYSTEMS FOR  
OTHER THAN SINGLE-FAMILY RESIDENCES

**APPENDIX A**

**STANDARDS FOR CONSTRUCTION OF MODIFIED SUBSURFACE  
SEWAGE DISPOSAL SYSTEMS AND SMALL COMMUNITY  
SEWERAGE SYSTEMS**

**September 25, 2023**

Gregson H. Pigott, MD, MPH  
Commissioner of Health Services

Walter Dawydiak, PE, JD  
Director of Environmental Quality

**TABLE OF CONTENTS**

<b><u>Section</u></b>	<b><u>Page</u></b>
A1. GENERAL/APPLICABILITY .....	1
A2. APPROVAL OF A MODIFIED SUBSURFACE SEWAGE DISPOSAL SYSTEM AND SMALL COMMUNITY SEWAGE SYSTEM TECHNOLOGY FOR USE IN SUFFOLK COUNTY .....	1
A3. SUBMISSION REQUIREMENTS .....	2
A4. SITING OF A MODIFIED SUBSURFACE SEWAGE DISPOSAL SYSTEM AND SMALL COMMUNITY SEWAGE SYSTEMS .....	2
A5. LOCATION OF MODIFIED SUBSURFACE SEWAGE DISPOSAL SYSTEMS AND SMALL COMMUNITY SEWAGE SYSTEMS .....	5
A6. SPECIAL DESIGN CONSIDERATIONS THAT MAY WARRANT REDUCED SEPARATION DISTANCES .....	6
A7. FINAL RECHARGE .....	9
A8. EXPANSION AREA REQUIREMENTS .....	9
A9. LABORATORY REQUIREMENTS .....	9
A10. ODOR REQUIREMENTS .....	9
A11. SPDES PERMIT REQUIREMENTS .....	10
A12. MONITORING WELLS .....	10
A13. FINAL APPROVAL REQUIREMENTS .....	11
A14. APPROVAL BY THE COMMISSIONER OF HEALTH SERVICES .....	12

**LIST OF TABLES**

TABLE A1 – MINIMUM SEPARATION DISTANCES .....	6
TABLE A2 – MODIFIED SEPARATION DISTANCES .....	8

**LIST OF FIGURES**

FIGURE A1 – TYPICAL MONITORING WELL .....	13
---	----

# **APPENDIX A**

## **STANDARDS FOR CONSTRUCTION OF MODIFIED SUBSURFACE SEWAGE DISPOSAL SYSTEMS AND SMALL COMMUNITY SEWERAGE SYSTEMS**

### **A1. GENERAL / APPLICABILITY**

This appendix sets forth standards for both modified subsurface sewage disposal systems (MSSDS), also known as denitrification systems, and for small community sewerage systems (SCSS) that do not exceed 30,000-gpd total design flow. Standards for collection systems (sewer mains) and for larger sewage treatment plants are not included herein. Refer to latest edition of Recommended Standards For Wastewater Facilities – GLUMRB, to Suffolk County Department of Public Works, and to **Appendix B** of these standards for sewer main and treatment plant requirements. These standards are applicable only for technologies that have received prior approval by the Department or NYSDEC for use within Suffolk County (See Section A2.).

These standards serve as a supplement to Standards For Approval Of Plans And Construction For Sewage Disposal Systems For Other Than Single Family Residences (STANDARDS) and include minimum separation distances from process tanks and leaching pools to buildings, property lines, and surface water. The statutory authority for this Appendix can be found in Article 6 Section 760-606 and 610 of the Suffolk County Sanitary Code.

Definitions of terms used herein can be found in the STANDARDS and in Article 6. When used in this Appendix, a “small” community sewerage system is defined as a community sewerage system with a total design sewage flow of less than or equal to 30,000 gallons per day (gpd). The standards in this Appendix apply to both MSSDS and SCSS. All plans for construction of new MSSDS and SCSS as well as plans to upgrade or expand existing systems must meet these requirements.

An MSSDS may be approved as a method of sewage disposal with a total design flow of at least 450-gpd and cannot exceed 30,000-gpd and the total nitrogen in the effluent stream cannot exceed 10 mg/l. Projects with a modified subsurface sewage disposal system must also connect to a community water supply.

### **A2. APPROVAL OF A MODIFIED SUBSURFACE SEWAGE DISPOSAL SYSTEM AND SMALL COMMUNITY SEWAGE SYSTEM TECHNOLOGY FOR USE IN SUFFOLK COUNTY**

All MSSDS and SCSS technologies must be designed for redundancy and receive approval for use in Suffolk County by either the Department or NYSDEC before any permanent installation of a MSSDS or SCSS technology is permitted. Manufacturers of MSSDS or SCSS technologies seeking approval directly from the Department must submit a design report in accordance with Department General Guidance Memorandum # 41 “Process for Approval of Sewage Treatment Plant Technologies for use in Suffolk County” requirements which include, but not limited to, technology brochures, structural drawings, structural calculations, process calculations, process schematics, component equipment list, operation and maintenance requirements, data from systems installed within the United States depicting the technology can meet NYS SPDES permit limits for consistently reducing total nitrogen to less than 10 mg/l. (including temporary demonstration systems installed at County municipal treatment plants), etc. If the MSSDS or

SCSS technology has not been installed within the United States, the Department may consider data from systems installed in other Countries on a case-by-case basis. The Department may require/request additional information from the manufacturer not specifically stated above to evaluate the MSSDS or SCSS technology.

In some cases, the Department may require the manufacture of a new technology to be utilized in Suffolk County to provide an insurance backed performance bond ensuring the proposed MSSDS or SCSS will meet treatment requirements or require site-specific letter of credit that include additional language. MSSDS or SCSS currently approved for use in Suffolk County for design flows up to 15,000 gpd may be required to submit additional documentation in order to obtain Department approval for design flows up to 30,000 gpd. The Department may also approve MSSDS or SCSS for specific wastewater flow ranges up to 30,000 gpd only (i.e., 450 to 15,000 gpd, 15,000 to 30,000 gpd, 450 to 30,000 gpd, etc.).

### **A3. SUBMISSION REQUIREMENTS FOR PROPOSALS WITH A MODIFIED SUBSURFACE SEWAGE DISPOSAL SYSTEM AND SMALL COMMUNITY SEWAGE SYSTEM TECHNOLOGY FOR USE IN SUFFOLK COUNTY**

Refer to **Application Requirements For Sewage Disposal Facilities & Water Supply Systems For Other Than Single Family Residences**, (WWM-003) for application procedures.

### **A4. SITING OF A MODIFIED SUBSURFACE SEWAGE DISPOSAL SYSTEM AND SMALL COMMUNITY SEWAGE SYSTEMS**

#### **1. AUTHORITY**

All proposed new or expansion MSSDS or SCSS shall undergo siting review by the Department to ensure conformance to Article 6, Sections 760-608 and 760-610, and Article 2, Section 760-221 of the Suffolk County Sanitary Code (SCSC). In addition, the Department performs siting reviews to help in protecting our water resources in accordance with Article 3, Section 760- 306, paragraphs 3 & 4 of the SCSC.

#### **2. PURPOSE**

Siting review of proposed or expanded MSSDS or SCSS are to determine potential impacts to existing or planned drinking water supplies, and surface water features such as wetlands, lakes, streams and embayments. Potential impacts to neighboring properties that may occur as a result of elevated groundwater levels or flooding may also be evaluated as required.

#### **3. GUIDANCE**

All proposed or expanded MSSDS or SCSS will require a separate siting review by the Department. The Department will continue to coordinate reviews with the appropriate public water suppliers that may be affected, and review potential impacts to private drinking water wells and surface water features as indicated above. Alternatives to the construction of MSSDS or SCSS should always be explored, including connection of the project to a municipal sewer district or to an existing off-site treatment facility. When performing siting reviews, the Department will evaluate potential impacts to existing or



planned public water supply wells and private drinking water supply wells from MSSDS or SCSS using a variety of resources. These may include, but not be limited to, Source Water Assessment data, hydrogeological reports, historical water quality results, and ground and surface water priority areas as defined in the latest version of the Suffolk County Department of Health Services Subwatersheds Wastewater Plan. The Department will also refer to the latest versions of applicable standards including, but not limited to, Appendices 5-B and 5-D of the New York State Sanitary Code. In addition, potential impacts should be evaluated as part of the Environmental Impact Statement (EIS) as part of the SEQRA process. The Department may require the applicant to supply a groundwater transport model analysis as part of a hydrogeologic evaluation for the project depending on the amount of sewage flow and proximity to existing and planned drinking water wells or surface waters.

Listed below is additional guidance that may be used when siting proposed or expanded MSSDS or SCSS.

### **Drinking Water Supplies**

- MSSDS or SCSS discharges shall not be located within the 0-2 year groundwater contributing areas to public supply wells, as identified as part of the 2007 Source Water Assessments prepared by Camp Dresser & McKee Environmental Consultants (CDM) or more recent hydrogeologic evaluations and Source Water Assessments where applicable. A 0-2 year travel time was determined as part of the NYSDOH's sensitivity analysis of microbial contaminants performed for the 2003 Source Water Assessment Plan (SWAP).
- Based on the potential for drinking water supplies to be impaired by emerging contaminants such as pharmaceutical and personal care products, including 1,4-dioxane, the Department has historically strongly discouraged MSSDS or SCSS discharges from being located within the 2-5 year groundwater contributing area to public supply wells.
- The siting of MSSDS or SCSS discharges within the 2-50 year groundwater contributing areas to public supply wells should be minimized to every extent feasible. However, when an MSSDS or SCSS discharge is located within the 2-50 year travel time, the applicant shall provide an advanced treatment process that consistently reduces the total nitrogen concentration to the maximum practical extent. In addition, the SPDES permit conditions issued for these systems shall require the nitrogen discharge goal be significantly lower than 10 mg/l. Tertiary treatment to address potential impacts from other contaminants and a performance bond may also be required.
- For STP discharges within the 2-50 year groundwater contributing areas to public supply wells, the applicant shall demonstrate that the nitrogen mass loading is significantly reduced by the proposed project by 10 percent or more, as compared with the mass loading that can occur with a development that complies with the density requirements of Article 6 of the SCSC. A total nitrogen concentration of 50 mg/l may be used when calculating the equivalent mass loadings.
- In accordance with Appendix 5-D of the New York State Sanitary Code, MSSDS or SCSS discharges shall not be located within 300 feet of a public water supply well.
- Separation distances between MSSDS or SCSS discharges and public water supply wells or their groundwater contributing areas shall be maximized to every extent practicable.

- In accordance with Appendix 5-B of the New York State Sanitary Code, MSSDS or SCSS discharges shall not be located within 200 feet of a private water supply well.
- When it is determined that private drinking water supplies may be impacted by the proposed project, the department may require that the applicant offer to connect affected dwellings served with private wells to a public water supply (this may necessitate the extension of public water to affected properties).

### **Surface Waters**

- The siting of MSSDS or SCSS discharges within 0-25 year groundwater contributing areas to sensitive surface waters should be minimized to the extent feasible. However, when an MSSDS or SCSS is located within this travel time, the applicant shall provide an advanced treatment process that consistently reduces the total nitrogen concentration to the maximum practical extent. In addition, the SPDES permit conditions issued for these systems shall require the nitrogen discharge goal be significantly lower than 10 mg/l.
- For MSSDS or SCSS discharges within 0-25 year groundwater contributing areas to sensitive surface waters, the applicant shall demonstrate that the nitrogen mass loading is significantly reduced by the proposed project by 10 percent or more, as compared with the mass loading that can occur with a development that complies with the density requirements of Article 6 of the SCSC. A total nitrogen concentration of 50 mg/l may be used when calculating the equivalent mass loadings.

### **Potential Impacts to Neighboring Properties**

- a. The Department may require the applicant to evaluate potential impacts to neighboring properties that may result from the construction and operation of a new MSSDS or SCSS. (e.g., flooding that may occur from elevated groundwater conditions). For these situations, the submission of a supplemental detailed technical report prepared by a design professional may be necessary.

## **4. PROCEDURE**

### **Submission of Preliminary Plans**

All design professionals are encouraged to submit preliminary plans that show the location of treatment and discharge facilities for any proposed or expanded MSSDS or SCSS prior to the environmental review process in order to ascertain general water resource concerns. Once the Department has reviewed the preliminary plans, additional information and/or submittals may be necessary to address any comments; it is also possible that an alternative site or revised proposal will be recommended prior to the SEQRA process. Submittal of preliminary proposals may be made prior to the submission of a formal application to the Department. A comprehensive engineering report is not typically required for these preliminary submissions; however, a sufficient amount of information must be provided to the department for review and evaluation. This includes:

- a. The proposed design flow and overall description of the treatment process
- b. A detailed site plan and layout of the plant and disposal facilities
- c. Surface contours, grading and elevations
- d. Soils borings, and groundwater elevations

- e. The nearest locations of the nearest public water supply wells and/or surface waters
- f. The location of any private wells within 500 feet of the proposed STP

## 5. EXCEPTIONS

Siting evaluations are performed on a case-by-case, site-specific basis, and include numerous complex variables, such as hydrogeology, soil conditions, projected sewage flow rates and existing groundwater quality. As such, the information listed above is for general guidance purposes only. In certain situations, alternative approaches and guidelines may be necessary to protect environmental health. In these cases, the Department will provide the rationale in writing for any variations to the above guidelines.

### A5. LOCATION OF MODIFIED SUBSURFACE SEWAGE DISPOSAL SYSTEMS AND SMALL COMMUNITY SEWAGE SYSTEMS

Modified subsurface sewage disposal systems and small community sewage systems shall be located to ensure that they do not cause contamination of drinking water supply wells. They shall be located to prevent airborne spread of pathogens and minimize nuisance odors and noise. Refer to the STANDARDS for additional information concerning the location and siting of sewage treatment facilities.

The following criteria also apply to these sites:

1. MSSDS and SCSS shall be located to maximize distances to drinking water supply wells. To protect the drinking water supply, all projects will undergo a separate site review within the Suffolk County Department of Health Services (SCDHS). If the SCDHS determines that insufficient distance exists to protect wells, or there is a preferred placement because of groundwater flow direction, further measures, including but not limited to relocation, effluent disinfection or additional sewage treatment may be required.
2. MSSDS and SCSS shall be located to maximize distances to freshwater wetlands, tidal wetlands, ponds, streams, and other surface waters, provided the minimum separation distances in Tables A1 and A2, are met.
3. MSSDS and SCSS shall be located in an area that is easily accessible for purposes of maintenance and / or replacement of sewage treatment or disposal facilities. Additionally, treatment and disposal facilities shall not be located within areas used for parking, easements or rights-of-way. Adequate security fencing shall be provided around all sewage treatment components.
4. A buffer area of one hundred (100) feet (ft.) shall be provided surrounding the area of the facilities including the expansion area. The buffer area shall be measured as a radius from the outermost dimensions of the tanks and expansion area. There shall be no substantial human use of the buffer area. Swimming pools, tennis courts or other recreational enhancements, parking lots, mailboxes or other building amenities shall not be located within the buffer area. This area shall be used exclusively for plantings that serve to screen the facilities from view. Effluent leaching pools may be placed in the buffer area.

5. MSSDS and SCSS shall be located as far as possible from human habitation, surface water, and areas of substantial use by the public. Separation distances, as listed in Table A1 below, are considered the **minimum** allowable and are based upon a typical system that is properly designed, constructed, well operated and judiciously maintained. Reasonable efforts should be made to ensure maintenance of these minimum separation distances, including evaluating alternative site layouts and changing density load.

**TABLE A1 - MINIMUM SEPARATION DISTANCES\*\***

Separation Distances From The Nearest Part Of:	To HABITABLE*	To NON-HABITABLE Building	To Area of Substantial Human Use (Buffer Area)	To Property Lines	To Surface Water
Enclosed Process Tanks and Expansion Area	200 ft.	100 ft.	100 ft.	150 ft.	100 ft. or as set by NYSDEC or local wetlands permit.
Leaching Pools and Galleys plus Expansion Area	25 ft.	25 ft.	May Be Included	25 ft.	100 ft. or as set by NYSDEC or local wetlands permit.

\* For purposes of this appendix, **HABITABLE** buildings include those buildings intended for permanent or transient residency or recreational use, and commercial buildings in substantial use by the public (i.e., condos, apartments, co-ops, PRC, assisted living, townhouses, hotels, motels, community clubhouses, office buildings, retail stores, restaurants, etc.).

\*\* The minimum separation distances found in TABLE 2 of the (main body of the) STANDARDS also apply to modified subsurface sewage disposal systems and small community sewerage systems.

6. In accordance with the New York State Department of Environmental Conservation publication, **Design Standards for Wastewater Treatment Works, Intermediate Sized Sewerage Facilities**, the minimum separation distances to on-site buildings or property lines listed in **Table A1** may be reduced if special designs or considerations warrant reduced distances. Special designs and considerations that may warrant reduced distances can be found in the following section of this document.

**A6. SPECIAL DESIGN CONSIDERATIONS THAT MAY WARRANT REDUCED SEPARATION DISTANCES.**

The separation distances as defined in **Section A5** above can be reduced when special site conditions exist or when the design of the modified subsurface sewage disposal system or small community sewerage system is enhanced beyond the level otherwise required by these standards, as defined in paragraph A6.2 below.

1. Special Site Conditions
  - a) When a MSSDS or SCSS is located near a property line, that abuts a recharge basin, a public roadway, divided highway, limited access roadway, railroad right-of-way, utility easement, or areas designated as permanent open space, the separation distance to that property line can be reduced. Such abutting property may be included when determining separation distances cited as applicable in Table A1. However, denitrification facilities (including leaching pools or galleys) shall not be placed closer than twenty-five (25) feet from the project property line.

- b) When a MSSDS or SCSS is located near a property line, that abuts a recharge basin, a public roadway, divided highway, limited access roadway, railroad right-of-way, utility easement, or areas designated as permanent open space, the separation distance to that property line can be reduced. Such abutting property may be included when determining separation distances to neighboring property lines cited as applicable in Table A2. However, denitrification facilities (including leaching pools or galleys) shall not be placed closer than ten (10) feet from the project property line and shall maintain the appropriate separation distance to neighboring property lines cited in Table A2 based on use of the use of the neighboring property line.

## 2. Air Quality and Noise Abatement Enhancements

Designs that provide for the adequate removal of aerosol emissions and the attenuation of odor and noise qualify for reduced separation distances.

### a) Aerosol Emissions and Odor Control

Aerosol emissions and odors shall be removed by venting all exhaust air from process equipment and pumping stations through a carbon filter designed for that purpose or through the use of other type of removal devices acceptable to the SCDHS. The carbon filter shall be designed for ease of replacement of carbon. General ventilation equipment shall be capable of providing at least six (6) air changes per hour. Odor control equipment shall be capable of operating when power to the treatment units has failed. Designs and equipment specifications shall be submitted to the review engineer for evaluation.

### b) Venting

Location and height of exhaust air ventilation shall be designed to minimize impacts to habitable areas.

### c) Noise Attenuation

Noise attenuation is required when reduced separation distances are requested. Blowers and exhaust fans shall be placed in an enclosure designed with a rating sufficient to attenuate noise levels from the equipment to a maximum of 50 dbA as measured at a distance of twenty-five (25) feet from the equipment.

3. Addition of all of the above enhancements shall allow the separation distance from enclosed process tanks, expansion area, and/or exhaust air discharge location to be reduced to habitable buildings, as previously defined, and to non-habitable buildings, such as separate garages or maintenance type buildings in accordance with Table A2. A buffer area as stated in Table A2 shall be provided. Swimming pools, parking areas, mailboxes, playgrounds, tennis courts, or any other amenities shall not be placed within buffer area. This buffer area may be reduced when special site conditions are present as described in paragraph A6.1 above. However, denitrification facilities (including leaching pools) shall not be placed closer than ten (10) feet from the project property line and shall maintain the appropriate separation distance to neighboring property lines cited in Table A2 based on use of the use of the neighboring property line.

This area shall be used for plantings that serve to screen the facilities from view. Effluent leaching pools or galleys may be placed in the buffer area. Modified distance requirements are summarized in Table A2.

**TABLE A2 - MODIFIED SEPARATION DISTANCES<sup>1</sup>**

Type of Use	Separation Distances From The Nearest Part Of:	To Habitable <sup>2</sup> Building	To NON-Habitable Building	To Area of Substantial Human Use (Buffer Area)	Distance to Neighboring Property Lines w/ Residential <sup>3</sup> Use	Distance to Neighboring Property Lines w/ Mixed Use	Distance to Neighboring property Lines w/ Commercial Use	To Surface Water
To Serve 100% Residential <sup>3</sup>	Enclosed Process Tanks and Expansion Area <sup>6</sup>	75 ft.	50 ft.	50ft. <sup>5</sup>	75 ft. <sup>4</sup>	25 ft. <sup>4</sup>	10 ft.	100 ft. or as set by NYSDEC or local wetlands permit
	Leaching Pools & Galleys plus Expansion Area	25 ft.	25 ft.	May Be Included	25 ft. <sup>4</sup>	10 ft.	10 ft.	100 ft. or as set by NYSDEC or local wetlands permit
To Serve 100% Commercial & Industrial	Enclosed Process Tanks and Expansion Area <sup>6</sup>	10 ft.	10 ft.	N/A	75 ft. <sup>4</sup>	25 ft. <sup>4</sup>	10 ft.	100 ft. or as set by NYSDEC or local wetlands permit
	Leaching Pools & Galleys plus Expansion Area	10 ft.	10 ft.	May Be Included	25 ft. <sup>4</sup>	10 ft.	10 ft.	100 ft. or as set by NYSDEC or local wetlands permit
Mixed Use Commercial & Industrial with a Max 50% Residential <sup>3</sup>	Enclosed Process Tanks and Expansion Area <sup>6</sup>	25 ft.	10 ft.	10 ft.	75 ft. <sup>4</sup>	25 ft. <sup>4</sup>	10 ft.	100 ft. or as set by NYSDEC or local wetlands permit
	Leaching Pools & Galleys plus Expansion Area	10 ft.	10 ft.	May Be Included	25 ft. <sup>4</sup>	10 ft.	10 ft.	100 ft. or as set by NYSDEC or local wetlands permit

<sup>1</sup> The minimum separation distances found in TABLE 2 of the (main body of the) STANDARDS also apply to modified subsurface sewage disposal systems and small community sewerage systems.

<sup>2</sup> For purposes of this Appendix, **HABITABLE** buildings include those buildings intended for permanent or transient residency or recreational use, and commercial buildings in substantial use by the public (i.e., condos, apartments, co-ops, PRC, assisted living, townhouses, hotels, motels, community clubhouses, office buildings, retail stores, restaurants, etc.).

<sup>3</sup> Residential uses/communities including but not limited to detached single-family dwellings, condominiums, townhouses, apartments, hotels, motels, co-operatives, planned retirement communities, nursing homes and assisted living facilities. (Note clubhouses, community buildings and/or gatehouses may be included as part of these types of residential communities)

<sup>4</sup> Separation distance to the project property line may be reduced to ten (10) feet when special site conditions as noted in paragraph A6.1b are present and when reduced distance does not interfere with future building setbacks for off-site vacant parcels.

<sup>5</sup> The buffer area may be reduced as noted in paragraph A6.3.

<sup>6</sup> Process Tanks include splitter boxes, wastewater screening/filtration devices (influent and effluent), and equalization tanks.

When a distance reduction is made for a multiple ownership project such as a condominium, the offering plan shall contain language indicating that special risks are present due to the reduction in distance.

Any reduction in the distances prescribed in Table A2, will require a variance from the SCDHS Board of Review.

#### **A7. FINAL RECHARGE**

Effluent from the treatment facility shall be piped to subsurface leaching systems in accordance with provisions in the STANDARDS. The maximum hydraulic leaching rate of 5 gallon per square foot per day (gal./sq.ft./day) shall be used without positive filtration. The maximum hydraulic leaching rate of 10 gal./sq.ft./day shall be used with positive filtration. Alternative designs for effluent disposal may be submitted for review by the SCDHS.

#### **A8. EXPANSION AREA REQUIREMENTS**

An adequate area shall be available to allow for a minimum of one hundred percent (100%) expansion/replacement of the modified subsurface sewage disposal systems and small community sewerage treatment and disposal facilities. The area provided for expansion/replacement shall be contiguous to the planned location of treatment and disposal facilities. Required buffer area shall be located outside of the expansion/replacement area for processes. Leaching pools or galleys and required expansion/replacement area for leaching may be placed within the buffer area provided that applicable separation distances listed in the tables are maintained. Deepening of leaching pools is not permitted in lieu of providing expansion/replacement area.

#### **A9. LABORATORY REQUIREMENTS**

All MSSDS and SCSS shall provide the means necessary for proper process control and operation. An area for laboratory facilities shall be provided in a building on the plant site. The laboratory shall be equipped with bathroom facilities and shall be heated and ventilated to provide an indoor temperature of at least 70 degrees F when the outside temperature is 0 degrees F.

#### **A10. ODOR CONTROL REQUIREMENTS**

The SCDHS reserves the right to require all remedial actions necessary; including but not limited to enclosing of odor and noise causing facilities and the installation of odor and emissions control equipment should nuisance conditions arise during actual plant operation. Approval of sewage treatment facility site location and design shall not be interpreted as relieving the owners from responsibility for remedial action should nuisance conditions arise in the future.

**A11. SPDES PERMIT REQUIRED**

A State Pollutant Discharge Elimination System (SPDES) permit, issued by the New York State Department of Environmental Conservation (NYSDEC), or its agent, is required prior to the issuance of a permit to construct. A SPDES permit is necessary when the project design sewage flow (total hydraulic load) is 1,000 gpd or greater. These permits require monitoring of the system influent, and effluent for flow and total nitrogen. Other parameters and sampling requirements may be imposed.

**A12. MONITORING WELLS****1. Applicability**

Monitoring wells are designed to provide a means of obtaining shallow groundwater quality samples in proximity to sewage treatment plant effluent discharges to assure that SPDES permit conditions are being met, to determine whether such conditions are adequate to protect groundwater, and other purposes determined by the commissioner of the SCDHS.

**2. Siting / Location**

The applicant's engineer shall include the location of all proposed and /or existing monitoring wells on the site plans together with the direction of groundwater flow. The required array of monitoring wells must provide a means of determining plant discharges on a continuous basis, and shall include the following:

- a) One (1) well up gradient of the effluent disposal facilities to monitor ambient groundwater quality. This well should be located at least 50 feet up gradient of any such facilities, beyond the influence of mounding at the water table caused by the recharged effluent.
- b) One (1) well down gradient of the effluent disposal facilities to monitor the impact of recharged effluent. These wells should be located no more than twenty-five (25) feet down gradient of disposal facilities.

The adequacy of proposed monitoring well arrays will be determined by the SCDHS based upon information contained in the plan submission, and on groundwater flow direction. The SCDHS reserves the right to require the installation of additional monitoring wells at any time. Access to all wells by the SCDHS and by the NYSDEC during normal working hours shall be assured.

**3. Specifications / Construction**

Monitoring wells shall conform to the following standards:

- a) Casings: 2-inch inside diameter Schedule 40 or 80 PVC; flush threaded.
- b) Screens: 2-inch inside diameter Schedule 40 or 80 PVC; 0.20-inch slots.
- c) Screen Length: 15 ft. minimum; may be greater depending upon the fluctuation in the local groundwater elevation.



- d) Filter Pack: Silica sand, uniformity coefficient < 1.7, effective size > 0.35 inch, 2 ft. above the top of the screen.
- e) Grouting: Grouting of the annular space above the filter pack is desirable, but not required; when included, a seal of fine silica sand - 2 inches thick- must be placed between the filter pack and grouting.
- f) Caps: Wells finished above grade must be protected by a 4-inch inside diameter steel casing secured with concrete collars and unthreaded, lockable caps. Wells finished below grade must be protected by suitable roadway, service or meter boxes (minimum 6 inches inside diameter).
- g) For a typical monitoring well detail, please refer to **Figure A-1**.

### A13. FINAL APPROVAL REQUIREMENTS

#### 1. Inspection

All sewage treatment and disposal system components must be inspected by the SCDHS to ensure conformance with the approved plans, reports and specifications. No portion of the system shall be backfilled until such time as the SCDHS has accepted the installation. A schedule for constructing the various components of the project shall be submitted to the SCDHS prior to the start of construction. A revised schedule will be required if anticipated construction is delayed more than two (2) weeks.

#### 2. Testing

The project engineer, and /or contractor shall perform tests of the sewage treatment system in accordance with the following criteria:

- a) Force mains shall be pressure tested for a minimum of 30 minutes @ 200 psi, or as recommended by the pipe manufacturer.
- b) Operation of all system components, including pumps, process equipment and electrical components.
- c) Leak testing of all tanks and pumping stations.

#### 3. Engineer's Certification

The project engineer shall certify that all sewage treatment system components have been constructed in accordance with approved plans, reports, specifications, and standards issued by the SCDHS. Refer to **Appendix C** of these standards for further information.

#### 4. Manufacturer's Certification

The project engineer shall submit Manufacturer(s) Start-Up Reports (MSR) for all major components. For example: pump station, generator set, process equipment, and flow meters.

#### 5. As - Built Plans

"As – Built" plans shall be submitted to the SCDHS for review and approval. These plans shall include all of the items listed in **Instructions For Obtaining Final Health Department Approval Of Constructed Projects For Other Than Single Family Residences**, (WWM-019)

6. Shop Drawings

Shop drawings of the major mechanical and electrical components shall be submitted to the SCDHS. For example, pumps, process equipment, and generator set.

7. Operation and Maintenance Manual

Modified subsurface sewage disposal systems and small community sewerage systems must be operated and maintained by a person or persons acceptable to the commissioner. To assist in this task, an operation and maintenance manual shall be submitted to and accepted by the SCDHS. The O & M manual shall conform to the requirements specified in the SCDHS **Sewage or Industrial Waste Treatment Facilities Operation and Maintenance Standards**.

**A14. APPROVAL BY THE COMMISSIONER OF HEALTH SERVICES**

In accordance with Article 2 and Article 6 of the Suffolk County Sanitary Code, the foregoing are the standards of the Suffolk County Department of Health Services for Appendix A of the Standards for Approval of Plans and Construction for Sewage Disposal Systems for Other Than Single-family Residences. These Standards are adopted and effective September 25, 2023.

*Signature on File*  
Gregson H. Pigott, MD, MPH  
Commissioner of Health Services  
Suffolk County

(Adopted 6/15/82; Amended 3/5/84, 2/5/88, 3/15/05, 7/15/08, 11/20/08, 12/1/09, 12/1/20, 9/25/23)

**Figure A1**

TYPICAL MONITORING WELL DETAIL

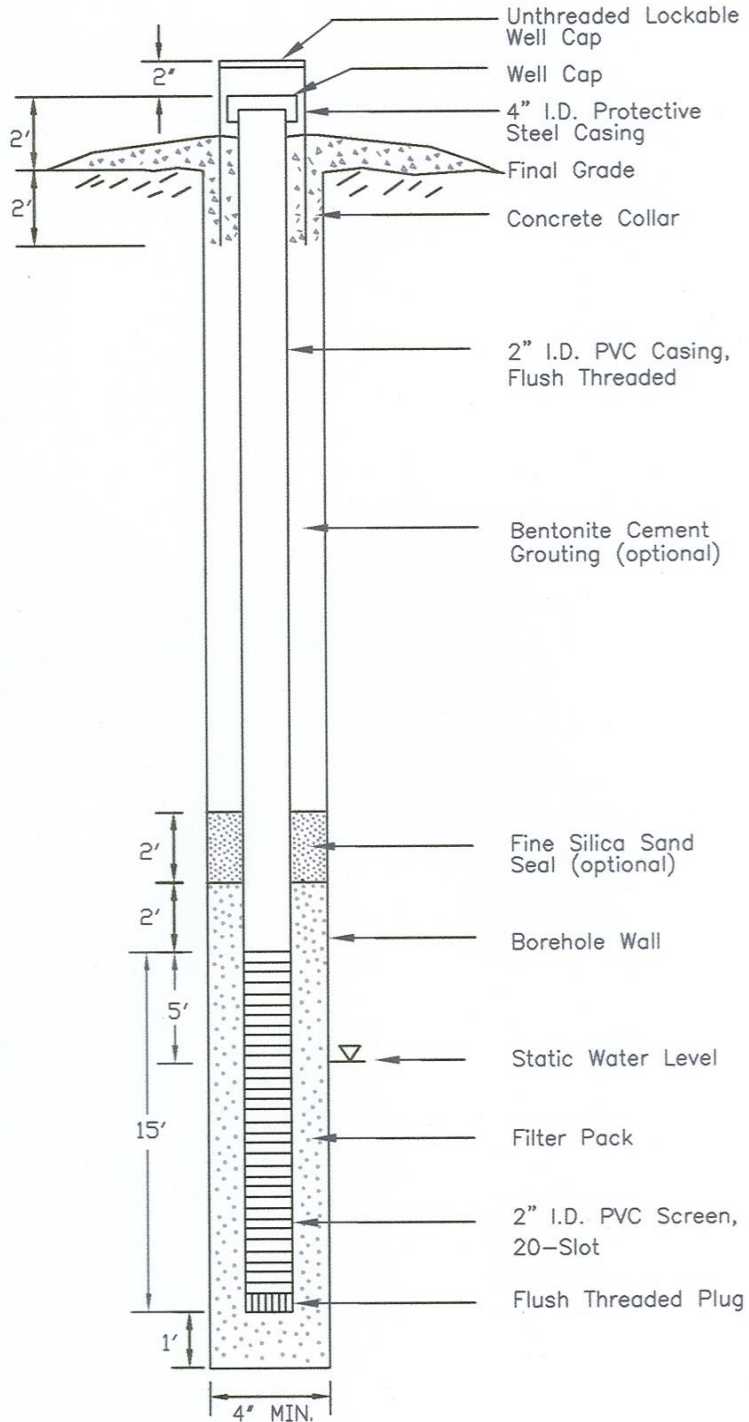

**STP Well Shop Drawing Form**

Date: \_\_\_\_\_  
 Project Name: \_\_\_\_\_  
 \_\_\_\_\_  
 Well Site #: \_\_\_\_\_  
 Driller: \_\_\_\_\_  
 Drilling Method: \_\_\_\_\_

Casing:  
 Manufacturer: \_\_\_\_\_  
 Type: \_\_\_ Sched. 40 \_\_\_ Sched. 80

Screen:  
 Manufacturer: \_\_\_\_\_  
 Type: \_\_\_ Sched. 40 \_\_\_ Sched. 80  
 Type: \_\_\_ Wire-Wound \_\_\_ Slotted

Filter Pack:  
 Manufacturer: \_\_\_\_\_  
 Uniformity Coefficient: \_\_\_\_\_  
 Effective Size: \_\_\_\_\_

Note 1: Screen setting and/or length may be modified to meet local conditions.

Note 2: Attach separate sheet for wells to be finished below grade showing construction details.

COUNTY OF SUFFOLK



STEVEN BELLONE  
SUFFOLK COUNTY EXECUTIVE

SUFFOLK COUNTY  
DEPARTMENT OF HEALTH SERVICES  
DIVISION OF ENVIRONMENTAL QUALITY

STANDARDS FOR APPROVAL OF PLANS  
AND CONSTRUCTION FOR  
SEWAGE DISPOSAL SYSTEMS FOR  
OTHER THAN SINGLE-FAMILY RESIDENCES

## **APPENDIX B**

### **STANDARDS FOR APPROVAL AND CONSTRUCTION OF SEWAGE COLLECTION SYSTEMS AND TREATMENT WORKS**

December 1, 2009

Gregson H. Pigott, MD, MPH  
Commissioner of Health Services

Walter Dawydiak, PE, JD.  
Director of Environmental Quality

**TABLE OF CONTENTS**

<b><u>Section</u></b>	<b><u>Page</u></b>
B1. ENGINEERING REPORTS .....	1
B2. TREATMENT UNITS .....	3
B3. LOCATION OF WASTE WATER TREATMENT FACILITIES .....	4
B4. PROCESS PIPING COLOR CODING .....	6
B5. LABORATORY REQUIREMENTS .....	7
B6. MONITORING WELLS .....	8
B7. RECHARGE DESIGN .....	9
B8. TESTING REQUIREMENTS.....	10
B9. SPDES PERMIT REQUIREMENTS .....	12
B10. FINAL APPROVAL REQUIREMENTS .....	12
B11. APPROVAL BY THE COMMISSIONER OF HEALTH SERVICES .....	14

**LIST OF TABLES**

TABLE B1 – REQUIRED MINIMUM SEPARATION DISTANCES .....	6
TABLE B2 – PIPE COLOR CODING .....	6
TABLE B3 – REQUIRED TEST EQUIPMENT .....	8

**LIST OF FIGURES**

FIGURE B1 – TYPICAL MONITORING WELL .....	15
---	----

## **APPENDIX B**

### **STANDARDS FOR APPROVAL AND CONSTRUCTION OF SEWAGE COLLECTION SYSTEMS AND TREATMENT WORKS**

#### **B1. ENGINEERING REPORTS**

Construction projects which include treatment works and/or large collection systems for sanitary wastes require supplemental design review and approval by the department prior to approval to construct being issued on the remainder of the project.

Design information is submitted to the department in the form of engineer's reports and plans and specifications. The department's review is conducted in two phases. The first phase is the submission of the engineering report. Following approval of this report, the second phase begins with submissions of plans and specifications. A copy of the final plans and specifications will be stamped with an approval stamp and returned to the authorized engineer. Projects with Suffolk County Sewer Agency contracts require review and approval by Suffolk County Department of Public Works in addition to Health Department review and approval.

All submitted documents shall bear the original seal and signature of an engineer licensed and registered to practice in New York State. Documents submitted shall be accompanied with a letter from the applicant authorizing the engineer to submit documents. Documents shall include a project application per WWM-003, SCDHS submission instructions.

Designs shall conform to the GLUMRB "Recommended Standards for Sewage Works" (Ten State Standards) except where the requirements following allow differences. The project engineering report shall conform to the outline presented in Chapter 10 of the aforementioned standards. For small non-municipal type sewage treatment plants, a less elaborate report is usually acceptable. However, as a minimum, the information outlined below shall be included in the report.

The engineering report is reviewed to evaluate whether: a proper basis for design has been established; the design criteria of the GLUMRB (Ten States) standards and Suffolk County Department of Health Services standards have been utilized; and the design has a reasonable expectation of meeting its objective.

The engineering report shall include:

1. Project name and description, including location, size and type of development and/or service area and future additions.
2. The following site plans and information:
  - a) A detailed site plan drawn accurately to scale of the planned development showing all property lines, topography, existing and proposed structures, rights-of-way, easements and proposed treatment plant site location. Scale shall not exceed 1 inch = 100 feet.

- b) A town zoning map delineating the area under study.
  - c) A tabulation of setback requirements for zoning classifications.
  - d) A detailed sewage treatment plant site plan of a scale no greater than 1 inch = 50 feet containing all information necessary to judge the suitability of the site location proposed. Typically, the plan must clearly detail an area of at least 500 feet surrounding the proposed plant site and must show all property lines, property ownership, property zoning, existing and future structures, rights-of-way, easements, water supply wells, surface water bodies, wetlands areas, storm water recharge facilities and utilities. Site plans shall bear the original seal and signature of a licensed professional engineer or architect registered for practice in the State of New York. The proposed STP shall not be located underneath the surface of the ground, such as under a parking lot, etc.
3. Soil information on at least two soil borings or test holes:
- a) In the recharge area.
  - b) At STP construction site.  
The boring or test hole location and log shall be placed on the site plan. Refer to Section 10 of the general standards "Subsoil and Groundwater Conditions" for detailed information on depth of boring or test hole.
4. A flow schematic of the proposed STP including piping and pumps, chemical additions, sludge system, recycle and return lines, etc.
5. A hydraulic profile through the STP from the influent sewer invert to the end of the effluent discharge pipe.
6. A statement of the effluent requirements to be met by the proposed treatment plant. In the case of discharge to groundwater, standards require that a Total Nitrogen (as N) concentration of 10 mg/l not be exceeded. Refer to NYSDEC Effluent Standards and/or Limitations for Discharges to Class GA Waters (6NYCRR 703.6).
7. Present and future population to be served and corresponding average daily and maximum hourly flows to the treatment plant.
8. Influent sewage characteristics, including BOD5, SS, TKN, etc.
9. A description of the treatment process:
- a) Indicate the design criteria used for sizing of the treatment units.
  - b) Show detailed calculations for the actual units being proposed.

10. A detailed discussion of the total air requirements at the STP. Indicate the size and number of blowers to be provided. In the case of the activated sludge process, the report shall show that sufficient air will be available for BOD reduction and conversion of the influent nitrogen to nitrate. Additional air shall be provided for the surge tank, digester, airlift pumps, sand filter backwash air scour, etc.
11. Detailed calculations for sizing of chemical storage tanks and feed equipment. The chemicals usually provided are sodium hypochlorite, methanol and caustic soda. Storage of chemicals shall conform to Article 12 of the Suffolk County Sanitary Code.
12. A narrative and design covering the following required items:
  - a) Potable water to the treatment plant and pump station, protected by an approved reduced pressure backflow prevention device.
  - b) Emergency standby power to maintain flow throughout the plant and for operation of other critical equipment.
  - c) An observation well in the vicinity of the leaching pools for monitoring groundwater.
  - d) A totalizer, indicator, recorder to monitor plant flow.
  - e) Laboratory facilities, including a lab bench with sink and test equipment to perform the required daily tests.
  - f) A control building to house the laboratory facility and the chemical feeders.
  - g) An enclosure for the blowers and electrical panel.
  - h) Color coding for process piping.
13. Further information if necessary or required by the Department.

## **B2. TREATMENT UNITS**

Typical biological nitrification - denitrification treatment processes used in Suffolk County are Extended Aeration Activated Sludge or Rotating Biological Contactors followed by Deep Bed Filters but other processes may be approved. The Deep Bed Filter accomplishes denitrification and solids removal and is equipped with an automatic backwash system. The influent to the filter is inoculated with a carbon source (methanol).

The total required clarifier and filter areas shall be divided among two or more units. Multiples of other treatment units may also be required.

Preliminary treatment devices shall be designed to remove or reduce in size large suspended or floating solids; to remove heavy inorganic solids; and to remove excess amounts of oils and grease.



Flow equalization shall be provided to dampen the diurnal flow variation, and thus achieve a constant or nearly constant flow rate through the downstream treatment processes. Separate equalization basins are required.

Facilities for disinfection of the sewage effluent shall be provided and designed in accordance with Ten State Standards.

Facilities for waste sludge handling and storage shall be provided and designed in accordance with Ten State Standards. For small size plants, an aerobic digester is usually provided. The report must also address final sludge disposal.

A control building shall be provided to house the laboratory facility and the chemical feeders. In addition, an enclosure shall also be provided for the blowers and electrical panel to protect the equipment from adverse weather and to reduce noise impact on the environment.

In the case of effluent recharge to groundwater, final disposal facilities may consist of subsurface leaching pools or a minimum of 4 recharge beds. The maximum allowable design rate for tertiary filtered effluent is 10 gpd per sf of pool sidewall area or bed bottom area (5 gpd per sf for unfiltered effluent). This rate is conditioned on acceptable soil conditions being encountered.

A minimum of 100 percent expansion/replacement area shall be provided for the sewage treatment plant and for future leaching facilities. This plant expansion area may be modified for small private plants if the property is fully developed.

### **B3. LOCATION OF WASTE WATER TREATMENT FACILITIES**

The site location for wastewater treatment facilities shall be selected to insure that public health hazards are not caused by airborne spread of pathogens and contamination of water supply wells. Care shall also be exercised to insure that neighboring resources are not degraded and that usage of neighboring properties are not impaired.

To protect the public water supply and the benefits that freshwater wetlands, tidal wetlands, ponds, streams and other surface waters provided, all projects within 1500 feet of a public water supply well or projects containing wetlands or surface waters will undergo a separate site review. The following criteria apply to these sites:

1. Wastewater treatment facilities shall be located to maximize distances to public water supply wells. If the department determines that insufficient distance exists to protect the well, further measures may be required.
2. Wastewater treatment facilities shall be located so as to maximize distances to freshwater wetlands, tidal wetlands, ponds, streams, and other surface waters, provided that the criteria in 1. above are satisfied. In no case may any portion of the facilities be placed closer than 100 feet from the boundaries of regulated freshwater wetlands, regulated tidal wetlands, ponds, streams, or other surface waters; or as set by NYSDEC or local wetlands permit.

3. A buffer area of one hundred (100) feet shall be provided surrounding the area of the facilities including the expansion area. The buffer area shall be measured as a radius from the outermost dimensions of the tanks and expansion area. There shall be no substantial human use of the buffer area. Swimming pools, tennis courts or other recreational enhancements, parking lots, mailboxes or other building amenities shall not be located within the buffer area. This area shall be used exclusively for plantings that serve to screen the facilities from view. Effluent leaching pools may be placed in the buffer area.

Separation distances, as hereinafter listed in Table 1, are considered to be the minimum allowable and are based upon a typical system being well operated and judiciously maintained. Every reasonable effort should be expended to provide separation distances in excess of those tabulated. The Department reserves the right to require all remedial actions necessary; including but not limited to, enclosing of odor causing facilities and the installation of adequate ventilation and odor destruction equipment should objectionable conditions arise during actual plant operation. Approval of water pollution control plant site location and design shall not be interpreted as relieving the owner from responsibility for remedial action should objectionable conditions arise in the future.

Below are separation distances which shall be maintained between water pollution control plant units and tenantable structures, and between water pollution control plant units and property lines of developed or buildable property. Where neighboring properties are currently vacant, separation distances shall be measured to the pertinent setback distance required by present zoning.

Where the tabulated separation distances are shown for enclosed facilities, those reduced distances are based upon inclusion within the enclosure of noise control, proper ventilation and positive odor removal devices. Ventilation systems shall be designed to maintain a negative pressure inside the enclosure with respect to the outside ambient environment of sufficient magnitude to prevent the inadvertent escape of noxious odors. Special emphasis should be placed on architectural detail to insure a "tight" enclosure.

Positive odor removal shall be taken to include ozonation, thermal incineration, oxidation by chemical oxidants, adsorption on sorptive media, or any like process which removes and/or destroys the odorous constituents of the ventilated gases. Use of masking agents shall not be permitted.

**TABLE B1 - REQUIRED MINIMUM SEPARATION DISTANCES**

	DISTANCE TO STRUCTURE OR BUILDING SETBACK	DISTANCE TO PROPERTY LINES
Sewage Treatment Processes Open To The Atmosphere	400' <sup>3</sup>	350' <sup>3</sup>
Sewage Treatment Processes Enclosed In a Building <sup>1</sup>	200' <sup>2,3</sup>	150' <sup>3</sup>
Effluent Recharge Beds	400' <sup>3</sup>	300' <sup>3</sup>
Leaching Pools	25'	25'
Chemical Storage	All chemical storage, whether in dry bulk form and/or liquid stored in tanks shall meet the provisions of Article 12 of the Suffolk County Sanitary Code.	

<sup>1</sup> Enclosed building designation requires ventilation, odor and noise control devices in accordance with good engineering practice.

<sup>2</sup> Non-residential structures located on the same parcel may qualify for lesser distances.

<sup>3</sup> 100 foot buffer to areas of substantial human use is to be included in this distance.

**B4. PROCESS PIPING COLOR CODING**

It shall be a requirement for all sewage treatment plants that process piping be color coded and identified with stenciled markings. Identification markings shall be stenciled at suitable locations on the piping and lettering shall be of such size to allow easy identification.

Unless otherwise approved, lettering shall be 2 inches high and spaced at no greater than 10'-0" between identifying markings. Color coding and identification markings shall be as follows:

**TABLE B2 – PIPE COLOR CODING**

SERVICE	COLOR	MARKING
Sludge	Brown	SL
Gas	Yellow with Red Bands 30 - inch intervals	G
Potable Water	Blue	C.W.
Sewage	Gray	S

SERVICE	COLOR	MARKING
Chlorine or Hypochlorite	Yellow	CL
Compressed Air	Green	A
Chemical	Orange	L - Lime F - Ferric M - Methanol Na - Caustic P - Polymer
Non-Potable Water (Recycled Effluent)	Orange with Red Band	X at 12 inch intervals
Fire Protection	Red	

## B5. LABORATORY REQUIREMENTS

All wastewater treatment facilities shall provide the means necessary for proper process control and operation. An area for laboratory facilities shall be provided in a building on the plant site. The building may also house process equipment, lavatory facilities, storage rooms, etc; however, the laboratory shall be isolated from other equipment and housed in an enclosure by means of partition walls and doors. The laboratory shall be heated and ventilated to provide an indoor temperature of at least 70 degrees F when the outside temperature is 0 degrees F. At least two duplex GFI 120V electric outlets shall be located in close proximity to laboratory benches. Outlets shall be located to allow operation of all electrical laboratory equipment on laboratory benches and tables. Lighting shall be provided to produce a light intensity of at least 50 foot-candles over the entire laboratory area and at least 100 foot-candles over laboratory benches.

Laboratories shall be equipped with ample bench and storage space to allow safe storage of equipment and reagents. The following storage and work space shall be supplied:

1. 1 - 60"L x 30"D x 36"H bench with at least 3 storage drawers and cupboard. The bench top shall be of corrosion resistant material;
2. 1 - 60"L x 12"H x 12"D shelf.
3. 1 adjustable lab stool.
4. 1 - 18"W x 29"D X 12"H steel file cabinet.
5. 1 lab sink manufactured of corrosion resistant material, equipped with 2 goose neck faucets suitable for heavy duty laboratory service, and serviced with hot and cold running water.

6. Suitable drainboards and drying racks.
7. Emergency eyewash and/or shower.

Facilities and an ample supply of test equipment shall be provided to perform the following tests at the STP for day to day operational control:

**TABLE B3 - REQUIRED TEST EQUIPMENT**

	TEST	EQUIPMENT REQUIRED
1.	Settleable solids	Imhoff cones
2.	Dissolved oxygen	Portable D.O. meter
3.	Ammonia nitrogen	Color comparitor
4.	Nitrite nitrogen	Color comparitor
5.	Nitrate nitrogen	Color comparitor
6.	TKN	Color comparitor
7.	pH	pH meter
8.	SVI	1000 ml graduated cylinders, centrifuge
9.	Total residual chlorine	Color comparitor
10.	Free residual chlorine	Color comparitor
11.	Temperature	Laboratory thermometer

Other tests on STP effluent parameters as listed in the discharge permit (SPDES permit) are to be performed by an approved outside laboratory and submitted monthly to authorities listed in the permit.

## **B6. MONITORING WELLS**

1. Applicability

Monitoring wells are designed to provide a means of obtaining shallow groundwater quality samples in proximity to sewage treatment plant effluent discharges to assure that SPDES permit conditions are being met, to determine whether such conditions are adequate to protect groundwater, and other purposes determined by the commissioner of the SCDHS.

2. Siting / Location

The applicant's engineer shall include the location of all proposed and /or existing monitoring wells on the site plans together with the direction of groundwater flow. The required array of monitoring wells must provide a means of determining plant discharges on a continuous basis, and shall include the following:

- a) One (1) well up gradient of the effluent disposal facilities to monitor ambient groundwater quality. This well should be located at least 50 feet up gradient of any such facilities, beyond the influence of mounding at the water table caused by the recharged effluent.
- b) Two (2) wells down gradient of the effluent disposal facilities to monitor the impact of recharged effluent. These wells should be located no more than twenty-five (25) feet down gradient of disposal facilities.

The adequacy of proposed monitoring well arrays will be determined by the SCDHS based upon information contained in the plan submission, and on groundwater flow direction. The SCDHS reserves the right to require the installation of additional monitoring wells at any time. Access to all wells by the SCDHS and by the NYSDEC during normal working hours shall be assured.

### 3. Specifications / Construction

Monitoring wells shall conform to the following standards:

- a) Casings: 2" inside diameter Schedule 40 or 80 PVC; flush threaded.
- b) Screens: 2" inside diameter Schedule 40 or 80 PVC; 0.20" slots.
- c) Screen Length: 15 feet minimum; may be greater depending upon the fluctuation in the local groundwater elevation.
- d) Filter Pack: Silica sand, uniformity coefficient  $< 1.7$ , effective size  $> 0.35"$ , 2 feet above the top of the screen.
- e) Grouting: Grouting of the annular space above the filter pack is desirable, but not required; when included, a seal of fine silica sand - 2 inches thick- must be placed between the filter pack and grouting.
- f) Caps: Wells finished above grade must be protected by a 4-inch inside diameter steel casing secured with concrete collars and unthreaded, lockable caps. Wells finished below grade must be protected by suitable roadway, service or meter boxes (minimum 6 inches inside diameter).
- g) For a typical monitoring well detail, please refer to **Figure B-1**.

## **B7. RECHARGE DESIGN**

Effluent from the treatment facility shall be piped to subsurface pre-cast concrete leaching pools in accordance with provisions in the STANDARDS or to recharge beds. Alternative designs for effluent disposal may be submitted for review by the SCDHS.

Recharge pools shall be designed on the basis of 10 gallons per day per square foot of sidewall area for filtered effluent or 5 gallons per day per square foot of sidewall area for unfiltered effluent. An area shall be set aside for future 100% expansion/replacement of the pools.

Recharge beds shall be designed on the basis of 10 gallons per day per square foot of bottom area for filtered effluent or 5 gallons per day per square foot of bottom area for unfiltered effluent. An area shall be set aside for future 100% expansion/replacement of the beds.

Beds shall be a maximum of four (4) feet in depth including freeboard, shall be equipped with access ramps for ease of cleaning and shall be equipped with splash pads at the ends of influent piping.

Beds shall be separated into four independent areas valved to allow alternate dosing.

For further information regarding recharge bed design consult the Department.

## **B8. TESTING REQUIREMENTS**

All testing shall be scheduled and conducted by the contractor prior to the operation of the plant. The Department of Health Services shall be given at least 48 hours notice prior to the start of any phase of the testing procedure. All testing shall be witnessed and reported by the engineer certifying construction.

Prior to testing, during the entire testing procedure, and prior to putting the plant into operation, all tanks, piping and appurtenances shall be cleaned and flushed of all debris, grease, oil, water and other deleterious materials. At no time shall the discharge from the flushing operation be allowed to pass through any equipment.

Prior to approval of any sewage treatment plant or pump station, all tanks, piping and appurtenances shall pass the following tests.

### **1. Exfiltration and Stability Test**

All tanks shall be subject to an exfiltration and stability test.

Prior to testing any tank or tank complex, the tank(s) shall be backfilled to finished grade and all piping and/or equipment within the tank which might affect the watertightness of the tank shall be completely installed and operable. A minimum of 8 elevations shall be obtained around the periphery of the outer walls of each tank or tank complex.

Each individual tank shall be isolated from other tanks by plugs, etc., and filled with clean water to the maximum operating level. After a suitable stabilization period, the maximum operating level shall be reestablished and an 8 hour leakage test shall be performed. During the test, no water shall be added to or taken from the tank. The change in water level shall be recorded at the end of the 8 hour period. Allowable loss is 1/4 inch in 8 hours. Any leaks shall be repaired by methods and materials approved by the engineer and the Department prior to the start of the corrective action, and all leakage shall be corrected prior to the performance of equipment testing. During the testing of each individual tank, all adjacent tanks shall be empty of all water.

After each individual tank has passed the 8 hour leakage test, all tanks within each complex shall be filled with water to the normal operating level. Elevations shall be obtained around the periphery at the same locations as prior to the leak test. Before and after elevations shall be reported to the department.

## 2. Wet Wells

Wet wells shall be filled to the maximum operating level or one foot above the crown of the influent pipe whichever is higher and tested as outlined above.

## 3. Infiltration Tests - Tanks and Wet Wells

In addition to the exfiltration tests outlined above, all tanks and wet wells which are constructed with the lowest elevation of the structure below normal groundwater shall be subject to an infiltration test. Each tank complex or wet well shall be completely backfilled, emptied of all water, and an infiltration test shall be conducted. It is intended that the test will be made after the groundwater has stabilized to normal elevation. A 48 hour continuous test period is required with the maximum allowable infiltration being 1/4 inch. Normal groundwater level shall mean the elevation to which groundwater stabilizes when unaffected by any dewatering operations within the area of influence.

## 4. Piping

In addition to flushing all pipe lines, the following requirements apply:

- a) Air system - prior to connection of diffusers and air lifts to the main piping, the system shall be run at maximum obtainable air flow to insure that all dust, dirt, scale, debris, etc., are scoured from the system. Piping shall be tested according to manufacturer's specifications.
- b) Other - Prior to operation, a piping system shall be tested and leaks repaired according to manufacturer's specification.

## 5. Equipment

All wiring and installation of appurtenances shall be completed prior to the testing of a piece of equipment. All machinery and equipment shall be put in service and tested under the supervision and direction of a representative of its manufacturer who has complete knowledge and responsibility for the equipment and is capable of making any adjustments and/or replacements required. All miscellaneous systems (alarm, remote telemetry, etc.) shall be tested from all access points. All required testing equipment shall be furnished by the contractor.

All blowers, pumps, generators, etc. shall be tested in place to insure that they do indeed conform to the requirements of the contract specifications. All motors shall be tested to insure that they do not exceed their name plate rating over the range of normal operation.



Engine generator sets shall be tested at full load conditions by simulating a utility power failure. All equipment which might normally be at load under power failure shall be in operation during this test.

After testing is completed to the satisfaction of the engineer and the Department, the manufacturers shall certify to:

- a) The proper installation of the equipment.
- b) The satisfactory compliance with testing requirements in accordance with design and approved specifications.
- c) The validation of equipment guarantees.

One copy of the above noted certification(s) on the manufacturer's letterhead shall be supplied to the Department by the certifying engineer.

## **B9. SPDES PERMIT REQUIRED**

A State Pollutant Discharge Elimination System (SPDES) permit, issued by the New York State Department of Environmental Conservation (NYSDEC), or its agent, is required prior to the issuance of a permit to construct. A SPDES permit is necessary when the project design sewage flow is 1,000 gpd or greater. These permits require monitoring of the system influent, and effluent for flow and total nitrogen. Other parameters and sampling requirements may be imposed.

## **B10. FINAL APPROVAL REQUIREMENTS**

### 1. Inspection

All sewage treatment and disposal system components must be inspected by the SCDHS to ensure conformance with the approved plans, reports and specifications. No portion of the system shall be backfilled until such time as the SCDHS has accepted the installation. A schedule for constructing the various components of the project shall be submitted to the SCDHS prior to the start of construction. A revised schedule will be required if anticipated construction is delayed more than two (2) weeks.

### 2. Engineer's Certification

The project engineer shall certify that all sewage treatment system components have been constructed in accordance with approved plans, reports, specifications, and standards issued by the SCDHS. Refer to **Appendix C** of these standards for further information.

### 3. Manufacturer's Certification

The project engineer shall submit Manufacturer(s) Start-Up Reports (MSR) for all major components. For example: pump station, generator set, process equipment, and flow meters.

4. As - Built Plans

"As – Built" plans shall be submitted to the SCDHS for review and approval. These plans shall include all of the items listed in **Instructions For Obtaining Final Health Department Approval Of Constructed Projects For Other Than Single Family Residences**, (OWM-019)

5. Shop Drawings

Shop drawings of the major mechanical and electrical components shall be submitted to the SCDHS. For example, pumps, process equipment, and generator set.

6. Operation and Maintenance Manual

Modified subsurface sewage disposal systems and small community sewerage systems must be operated and maintained by a person or persons acceptable to the commissioner. To assist in this task, an operation and maintenance manual shall be submitted to and accepted by the SCDHS. The O & M manual shall conform to the requirements specified in the SCDHS **Sewage or Industrial Waste Treatment Facilities Operation and Maintenance Standards**.

**B11. APPROVAL BY THE COMMISSIONER OF HEALTH SERVICES**

In accordance with Article 2 and Article 6 of the Suffolk County Sanitary Code, the foregoing are the standards of the Suffolk County Department of Health Services for Appendix B of the Standards For Approval of Plans And Construction For Sewage Disposal Systems For Other Than Single-family Residences. These Standards are adopted December 1, 2009 and are effective for applications received after January 1, 2010.

Signature on File

---

James L. Tomarken, MD, MPH, MBA, MSW  
Commissioner of Health Services  
Suffolk County

(Adopted 6/15/82; Amended 3/5/84, 2/5/88, 7/15/08, 11/20/08, 12/1/09, 12/29/17)

Figure B1

TYPICAL MONITORING WELL DETAIL

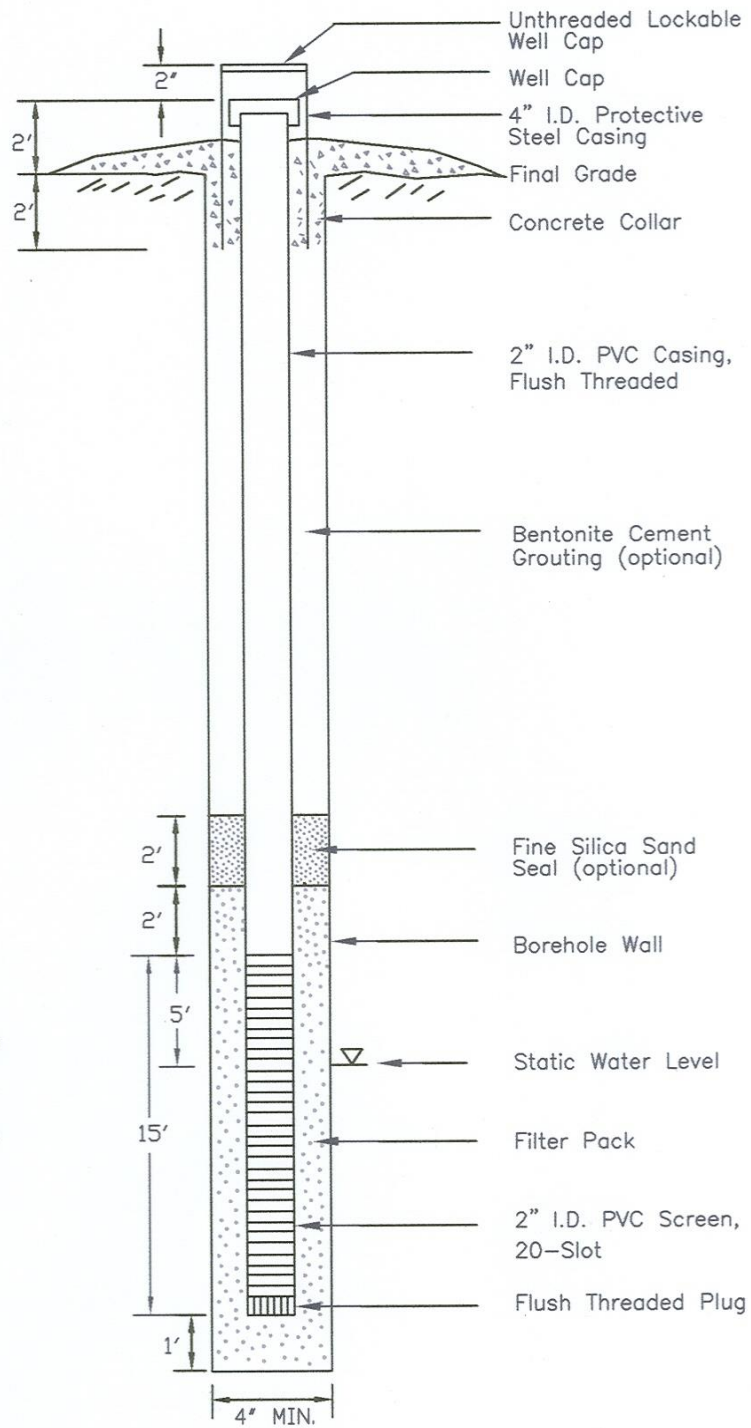

**STP Well Shop Drawing Form**

Date: \_\_\_\_\_

Project Name: \_\_\_\_\_

Well Site #: \_\_\_\_\_

Driller: \_\_\_\_\_

Drilling Method: \_\_\_\_\_

**Casing:**

Manufacturer: \_\_\_\_\_

Type:  Sched. 40  Sched. 80

**Screen:**

Manufacturer: \_\_\_\_\_

Type:  Sched. 40  Sched. 80

Type:  Wire-Wound  Slotted

**Filter Pack:**

Manufacturer: \_\_\_\_\_

Uniformity Coefficient: \_\_\_\_\_

Effective Size: \_\_\_\_\_

Note 1: Screen setting and/or length may be modified to meet local conditions.

Note 2: Attach separate sheet for wells to be finished below grade showing construction details.

COUNTY OF SUFFOLK



STEVEN BELLONE  
SUFFOLK COUNTY EXECUTIVE

SUFFOLK COUNTY  
DEPARTMENT OF HEALTH SERVICES  
DIVISION OF ENVIRONMENTAL QUALITY

STANDARDS FOR APPROVAL OF PLANS  
AND CONSTRUCTION FOR  
SEWAGE DISPOSAL SYSTEMS FOR  
OTHER THAN SINGLE-FAMILY RESIDENCES

**APPENDIX C**

**REQUIREMENTS OF DEPARTMENT OF HEALTH SERVICES  
AND RESPONSIBILITIES OF LICENSED DESIGN PROFESSIONALS  
IN INSPECTING SEWAGE TREATMENT WORKS OR  
COLLECTION SYSTEMS**

December 1, 2009

Gregson H. Pigott, MD, MPH  
Commissioner of Health Services

Walter Dawydiak, PE, JD  
Director of Environmental Quality

**TABLE OF CONTENTS**

<b><u>Section</u></b>	<b><u>Page</u></b>
C1. GENERAL .....	1
C2. SCHEDULE OF INSPECTIONS OF COMPLETED SEGMENTS OF SEWAGE TREATMENT WORKS .....	4
C3. SCHEDULE OF INSPECTIONS OF COMPLETED SEGMENTS OF COLLECTION SYTEMS .....	5
C4. APPROVAL BY THE COMMISSIONER OF HEALTH SERVICES .....	6

**LIST OF FORMS**

FORM C1 – AUTHORIZATION OF LICENSED PROFESSIONAL ENGINEER OR REGISTERED ARCHITECT.....	2
FORM C2 – CERTIFICATION OF CONSTRUCTED WORKS BY DESIGN PROFESSIONAL .....	3

## **APPENDIX C**

### **REQUIREMENTS OF DEPARTMENT OF HEALTH SERVICES AND RESPONSIBILITIES OF LICENSED DESIGN PROFESSIONALS IN INSPECTING SEWAGE TREATMENT WORKS OR COLLECTION SYSTEMS**

#### **C1. GENERAL**

The Suffolk County Department of Health Services requires that installation of sewage treatment works and collection systems be certified by a licensed professional engineer or registered architect as compliance of construction with Department standards.

The Suffolk County Department of Health Services prefers that the duties of construction inspection be carried out by the architect or engineer responsible for designing the project. However, an independent licensed professional engineer or registered architect is acceptable to the Department provided that the design professional and the owner authorize the choice. In order to assure impartiality, the inspecting personnel must have no financial or other vested interest in the construction contractor or installer. In cases where the design professional acts as contractor, the inspecting personnel must be independent.

This appendix contains samples of certificates and log sheets to be used in the certification procedure. All are to be submitted to the Department at time of application for final approval except for Authorization of Design Professional which must be submitted prior to commencing construction. Certain larger projects require pre-job meetings prior to commencing construction. Authorization may be submitted to the Department at this meeting.

**Suffolk County Department of Health Services - Form C1**

**AUTHORIZATION OF LICENSED PROFESSIONAL ENGINEER OR REGISTERED ARCHITECT FOR THE INSPECTION OF INSTALLATION OF**

modified subsurface sewage disposal system

sewage treatment plant    collection system

HEALTH DEPARTMENT REFERENCE NUMBER \_\_\_\_\_

Suffolk Tax Map #:

DIST. \_\_\_\_\_ SECT. \_\_\_\_\_ BLOCK \_\_\_\_\_ LOT \_\_\_\_\_

Statement of Owner: I hereby state that I have (check one): employed authorized retained

Name \_\_\_\_\_

Name of Firm \_\_\_\_\_

a licensed Professional Engineer  a registered Architect

to perform controlled inspection work for the above specified installation.

Signature \_\_\_\_\_  
(owner or officer of corporation)

Print Name \_\_\_\_\_

Title \_\_\_\_\_

Date \_\_\_\_\_

Address \_\_\_\_\_

Statement of L.P.E. or R.A. preparing plans (if inspecting engineer is different):

Name of licensed P.E. or R.A. preparing plans \_\_\_\_\_

Address \_\_\_\_\_

I hereby certify that \_\_\_\_\_ the L.P.E.  the R.A.  
(name)

engaged by the owner to perform the controlled inspection of the above specified installation is acceptable to me.

Signature \_\_\_\_\_ Date \_\_\_\_\_  
(Affix seal)

Statement of L.P.E. or R.A. performing inspections:

I, \_\_\_\_\_, have assumed responsibility for the inspection of the work designated above. I personally, or qualified personnel under my direct supervision in accordance with New York State Education Law, will be present during the installation and will perform the required inspections and tests, and all required inspection and test reports shall be signed by me and filed with the Suffolk County Department of Health Services.

I certify that I have no financial or other vested interest in the construction company(ies) or contractor(s) performing work on the systems I have inspected.

Signature \_\_\_\_\_ Date \_\_\_\_\_  
(Affix seal)



Suffolk County Department of Health Services
Office of Wastewater Management
360 Yaphank Avenue, Suite 2C
Yaphank, New York 11980
(631) 852-5700

CERTIFICATION OF CONSTRUCTED WORKS BY DESIGN PROFESSIONAL – Form C2

HEALTH DEPARTMENT REFERENCE NUMBER \_\_\_\_\_

Suffolk Tax Map #:

DIST. \_\_\_\_\_ SECT. \_\_\_\_\_ BLOCK \_\_\_\_\_ LOT \_\_\_\_\_

Project Name \_\_\_\_\_

Applicant's Name \_\_\_\_\_

ITEMS BEING CERTIFIED (Check all that apply)

- Sewer Lines and Sewage Collection System Components
Retaining Walls (approved as part of the sewage disposal system)
Sewage Pump Station / Valve Chamber
Subsurface Sewage Disposal System
Sewage Treatment Plant
Water Supply System
Abandonment of Preexisting Sewage Disposal System and /or Water Supply
Other

As the Licensed Professional Engineer or Architect I, or qualified personnel under my direct supervision, have inspected the work specified above in accordance with the New York State Education Law, and (check one)

- I hereby certify that all material and work conforms to approved plans and permit conditions, and with guidelines issued pursuant to the Suffolk County Sanitary Code. (Attach any inspection or test reports required by the Department.)
I hereby certify that all material and work conforms to approved plans and permit conditions, and with guidelines issued pursuant to the Suffolk County Sanitary Code, except as described in my attached addendum. (Also attach any inspection or test reports required by the Department.)

Engineer's / Architect's signature \_\_\_\_\_

Print Name \_\_\_\_\_ Date \_\_\_\_\_
(Affix seal)

License Number \_\_\_\_\_

This certification shall not be used in lieu of inspections required by personnel of the Department

**C2. SCHEDULE OF INSPECTIONS OF COMPLETED SEGMENTS OF SEWAGE TREATMENT WORKS**

The inspecting personnel are responsible to complete inspection of all aspects of a sewage treatment plant and or pump stations. The following schedule outlines the major components to be inspected. The inspector shall submit a log with his certification indicating that each component or segment was satisfactorily completed, date, time and length of each inspection, and initials of the person performing the inspection.

1. Concrete forms and reinforcing steel shall be inspected for proper placement.
2. All placement of concrete shall be inspected. Six test cylinders shall be taken for each 50 cu. yds. of concrete required. Weather conditions and temperature shall be recorded during placement of concrete.<sup>1, 4</sup> Detention time of concrete in each truck shall be recorded as well.
3. Treatment plant equipment installation(s) and checkout by manufacturer's service representative. This includes but not limited to the following items:
  - a) Effluent Filter System
  - b) Odor Control System
  - c) Emergency Generator
  - d) Flow Meter and Chart Recorder.
4. Exfiltration and stability tests.
  - a) Inspection and leak testing of all tanks to assure that tanks are installed and sealed in accordance with manufacturer's specifications.<sup>1,3</sup>
  - b) Inspection and leak testing of pump stations.<sup>1,3</sup>
5. Infiltration tests for tanks and wet well situated below groundwater level.
6. Construction of the Control Building and installation of the proposed appurtenances in accordance with approved plans and specifications.
7. Piping test in accordance with manufacturer's specifications.
8. Final leaching pools or recharge basins.<sup>4</sup>
9. Cast iron covers.
10. Proper backfilling.<sup>1,2</sup>

11. Final grading.
12. Proper fencing.
13. Construction of bollards as necessary.
14. Installation of groundwater monitoring well.<sup>4</sup>
15. Proper lighting in the area of treatment facility and/or pump stations.

Should any unforeseen field conditions necessitate changes on the plans and/or specifications, the inspecting personnel shall notify the Department immediately.

- 
- <sup>1</sup> Requires full time presence of inspecting design professional or qualified personnel under a design professional's supervision during installation.
  - <sup>2</sup> Sieve analysis to assure that sand and gravel is clean and conforms to specifications.
  - <sup>3</sup> Leak testing of all watertight chambers. See Appendix B for leak test requirements for watertight chambers.
  - <sup>4</sup> Requires call-in to Department 48 hr. prior to commencement of installation.

### **C3. SCHEDULE OF INSPECTIONS OF COMPLETED SEGMENTS OF COLLECTION SYSTEMS**

The inspecting personnel are responsible to complete inspection of all aspects of a collection system. The following schedule outlines the major components to be inspected. The inspector shall submit a log with his certification indicating that each component or segment was satisfactorily completed, date, time and length of each inspection, and initials of the person performing the inspection.

1. All sewer piping (installation and grade). Inspection of piping shall assure that all pipe is of proper size, type and class; that construction is according to specifications and installed properly; that pipe is run at proper slope and alignment; and that all joints are properly constructed; that the invert elevations of pipes at all crossings (sewer-water, sewer-drainage and water-drainage) are maintained in accordance with plans approved for construction.
2. Lift station(s) construction and equipment installation.
3. Pipe to manhole connections.
4. Manhole flow channel and bench.
5. House connections.
6. Pipe exfiltration, infiltration, deflection, leakage and pressure tests.<sup>1,2</sup>

Should any unforeseen field conditions necessitate changes on the plans and/or specifications, the inspecting personnel shall notify the Department immediately.

- 
- <sup>1</sup> Requires full time presence of inspecting design professional or qualified personnel under a design professional's supervision during installation.
  - <sup>2</sup> Requires call-in to Department 48 hr. prior to commencement of installation.

**C4. APPROVAL BY THE COMMISSIONER OF HEALTH SERVICES**

In accordance with Article 2 and Article 6 of the Suffolk County Sanitary Code, the foregoing are the standards of the Suffolk County Department of Health Services for Appendix C of the Standards for Approval of Plans and Construction for Sewage Disposal Systems for Other Than Single-family Residences. These Standards are adopted December 1, 2009 and are effective for applications received after January 1, 2010.

Signature on File

---

James L. Tomarken, MD, MPH, MBA, MSW  
Commissioner of Health Services  
Suffolk County

(Adopted 6/15/82; Amended 3/5/84, 2/5/88, 7/15/08, 11/20/08, 12/1/09, 12/29/17)